



# ***AR-Mini***

**COMMUNICATIONS RECEIVER  
100 kHz – 1299.995 MHz**



# FCC WARNING



Changes or modifications not expressly approved by the party responsible for compliance could void the user's authority to operate the equipment.

## ■ Part15 class B

---

### **NOTICE:**

This equipment has been tested and found to comply with the limits for a Class B digital device, pursuant to part 15 of the FCC Rules. These limits are designed to provide reasonable protection against harmful interference in a residential installation.

This equipment generates, uses and can radiate radio frequency energy and, if not installed and used in accordance with the instructions, may cause harmful interference to radio communications. However, there is no guarantee that interference will not occur in a particular installation. If this equipment does cause harmful interference to radio or television reception, which can be determined by turning the equipment off and on, the user is encouraged to try to correct the interference by one or more of the following measures:

- Reorient or relocate the receiving antenna
- Increase the separation between the equipment and receiver.
- Connect the equipment into an outlet on a circuit different from that to which the receiver is connected.
- Consult the dealer or an experienced radio/TV technician for help.

## ■ Part15 Class C

---

This device complies with Part 15 of the FCC Rules. Operation is subject to the following two conditions: (1) this device may not cause harmful interference, and (2) this device must accept any interference received, including interference that may cause undesired operation.

# CONTENTS

<b>FOR SAFETY</b> .....	5	Changing the 2VFO watch reception memory.....	33
<b>INTRODUCTION</b> .....	8	VFO search .....	34
Contents list .....	8	Skipping the desired frequency in a search .....	34
Part names and functions.....	9	Limit search .....	35
Description of LCD (Liquid Crystal Display) .....	12	Changing the search type .....	36
<b>PREPARATION AND BASIC USAGE</b> .....	13	Changing the search band memory .....	36
Connect the antenna .....	13	Limit link search .....	37
Attach the belt clip.....	14	Memory .....	38
Tie the hand strap.....	14	Storing a frequency in memory .....	39
Install the supplied Ni-MH batteries or AA batteries.....	15	Recalling memory .....	39
Charge the supplied Ni-MH batteries.....	16	Returning to VFO with displaying memory frequency .....	40
Basic usage.....	18	Erasing memory .....	40
Quick guide: Scan frequencies previously saved in a memory bank .....	20	Erasing all memories from the memory bank .....	41
Storing a frequency in memory bank ...	20	Naming memory .....	42
Scanning the memory bank .....	20	Memory scanning .....	42
Options list .....	21	Setting skipped memory when scanning .....	43
Using the DC-mini DC adapter .....	21	Scanning the memory bank.....	43
Using the CO-mini clone cable .....	22	Scanning a linked memory bank .....	44
Using the PC-mini programing cable .....	22	Using broadcast facility .....	45
Preparations.....	22	Using preset.....	45
Connecting PC-mini.....	23	Using tone squelch (CTCSS).....	46
Connecting with the AR-mini.....	23	Searching tone frequency.....	46
Running the PC-mini program.....	24	Reversed tone squelch function.....	47
<b>BASIC OPERATION</b> .....	25	Using DCS.....	47
Switching on .....	25	Using the voice inverter .....	48
Adjusting the volume .....	26	Using the attenuator .....	48
Adjusting the frequency.....	27	Using key lock.....	48
Adjusting the squelch .....	28	Searching bug frequencies.....	49
Changing the mode .....	29	Using the bug detector function.....	49
Monitoring.....	29	Resetting system (system reset) .....	50
Setting the AR-mini.....	30	Resetting all contents (all reset) .....	50
<b>ADVANCED OPERATION</b> .....	31	<b>CHANGING SETTINGS</b> .....	51
Finding the desired frequency.....	31	Changing steps .....	51
Priority watch .....	31	Changing fast steps .....	51
2VFO watch.....	32	Setting the lamp function .....	52
2VFO watch with 2VFO watch reception memory .....	33	Setting the timer .....	52
		Setting the S-meter sensitivity .....	53
		Setting the S-meter buzzer.....	54
		Setting the resumption time .....	54

# CONTENTS

Setting the search.....	55
Setting the memory scan .....	56
Setting the limit link search .....	57
Setting the memory for a memory bank link scan.....	58
Confirming limit search frequencies...59	
Erasing all memory from a memory bank .....	59
Erasing VFO skip memory .....	60
Erasing the memory channel's skip mark.....	61
Cancelling muting during a scan .....	61
Antenna selection .....	62
Using the earphone as an antenna.....	62
Automatically increasing the volume in FM .....	63
Setting tone frequency .....	63
Selecting reversed tone frequency.....	64
Selecting voice inverter carriers .....	64
Automatically switching the display information.....	65
Setting DCS codes .....	65
Setting the DCS code phases .....	66
Turning the beep off.....	66
Changing the battery saving time.....	67
Displaying battery voltage .....	67
Charging the Ni-MH battery .....	68
Revising step frequency .....	69
Shifting the microprocessor's clock frequency.....	69
<b>APPENDIX.....</b>	<b>70</b>
Broadcast facility frequencies .....	70
Bug frequencies.....	70
Preset memory frequencies .....	71
Shortwave broadcast station list.....	72
Tone frequency list (CTCSS).....	73
DCS code list .....	73
Search band memory list.....	74
2VFO watch memory list.....	74
Setting number list.....	75
Troubleshooting .....	78
Specifications .....	79

# FOR SAFETY

To ensure proper use of the receiver, carefully read the “For Safety” section prior to use.

After you have read it, keep this operating manual and the warranty handy in case you need them in the future.

## Icon Labels

A variety of icon labels are used in this operating manual to ensure safe use of the product, to prevent injury to yourself and others, and to prevent property damage. Make sure you fully understand the meanings of the icon labels after reading this operating manual.



### WARNING

This label is used in cases where there may be the possibility of death or serious injury.



### CAUTION

This label is used in cases where there may be the possibility of serious or minor injury.

## Icon label examples



Electric shock caution

A  $\triangle$  is used in cases where caution (danger, warning) is urged. Inside the triangle, the specific type of caution is indicated (in the example shown here, the caution is an electric shock caution).



Disassembly not allowed

A  $\circ$  with a line through it is used in cases where a particular action is not allowed. Inside the circle, or near it, the specific type of action which is not allowed is indicated (in the example shown here, disassembly is not allowed).



Remove plug from outlet

A  $\bullet$  (black circle) is used to indicate an action to be performed by the user. In the example shown on the left, the action shown is removal of the AC adapter power plug from the wall outlet.



## WARNING



Prohibition

- Do not insert anything metallic or flammable into the equipment. Doing so may result in fire or damage to the equipment.
- Do not place any container filled with water or other liquids, or small pieces of metal, on top of or near the AR-mini. In such cases, fire may result if the liquid is spilled on the AR-mini or if metal enters the unit.

- Fire, electric shock, or damage to the equipment may result if the charger is used under abnormal conditions (e.g., if it is emitting smoke, or strange odors or noises). In such cases, immediately remove the AC adapter power plug from the outlet. Make sure the charger stops emitting smoke, then contact your dealer to have it repaired. Never try to repair the equipment yourself: it is dangerous to do so.



Remove plug from outlet

- If water enters the AR mini or AC adapter, remove the AC adapter power plug from the power outlet and contact your dealer. Using the charger under such conditions may result in fire, electric shock, or damage to the equipment.
- If a foreign object enters the AR mini or AC adapter, remove the AC adapter power plug from the power outlet and contact your dealer. Using the charger under such conditions may result in fire, electric shock, or damage to the equipment.
- If you drop or damage the AR mini or AC adapter, be sure to remove the AC adapter power plug from the power outlet and contact your dealer. Using the charger under such conditions may result in fire, electric shock, or damage to the equipment.



Disassembly not allowed

- Do not disassemble or modify the AR-mini and AC adapter. Doing so may result in a fire, electric shock, or damage to the equipment.

# FOR SAFETY

## WARNING



- Do not disassemble the battery. Doing so may cause the battery to leak, heat up, or burst.



- Do not throw used batteries into a fire. Batteries thrown into a fire may explode, resulting in uncontrollable fire or burns.
- Do not short-circuit the battery terminals. Doing so may result in burns due to heat buildup. A battery could be shortcircuited if you carry it by itself.



- Do not use the AC adapter at voltages other than 100–240 V with an AC power supply. Doing so may result in fire, electric shock, or damage to the equipment.
- Do not use a power strip. Doing so may result in fire or overheating.



- Only use the AC adapter that is designed for use with the AR-mini. Using different equipment may result in fire, electric shock, or damage to the equipment.



- Do not modify, excessively bend, twist, or pull on the AC adapter or DC output cord. Doing so may result in fire or electric shock.
- If the AC adapter or DC output cord is damaged, have the cord replaced by the dealer. Failure to do so may result in fire or electric shock.



- Do not short-circuit the DC plug with metal. Doing so may result in fire or damage to the equipment.
- Do not charge the AR-mini if there are any water droplets on the DC plug. Doing so may result in fire or damage to the equipment.
- If lightning occurs near the equipment, remove the AC adapter power plug from the power outlet. Lightning may cause fire, electric shock, or damage to the equipment.

## WARNING



- Do not use the AC adapter as a power supply for other equipment. Doing so may result in fire, electric shock, or damage to the equipment.
- Do not place any heavy object on the power cord, and do not place the cord beneath such equipment. Doing so may damage the cord, resulting in fire or electric shock. Note: If the cord is placed under a carpet or the like, someone may fail to notice the cord and inadvertently place something heavy on top of it.



- Do not remove or insert the AC adapter power plug with wet hands. Doing so may result in electric shock.

## CAUTION



- If you are not going to be using the AR-mini or AC adapter for an extended length of time (e.g., if you are taking a vacation), be sure to remove the AC adapter power plug from the outlet as a safety precaution.
- Do not use the AR-mini or AC adapter in humid or dusty locations. Doing so may result in fire, electric shock, or damage to the equipment.
- Use and store the AR-mini and AC adapter in a location that is inaccessible to small children.
- Do not use the AR-mini or AC adapter on unstable surfaces. The units may fall or be tipped over if installed in such locations, resulting in injury or damage to the equipment.
- Do not use the AR-mini or AC adapter in locations subject to significant vibrations or mechanical shocks. The units may fall or be tipped over if installed in such locations, resulting in injury or damage to the equipment.
- Do not place the DC cord of the AC adapter near a heater. In such cases, the cord sheathing may melt, resulting in fire or electric shock.

# FOR SAFETY

## CAUTION



Remove  
plug from  
outlet

- When removing the AC adapter power plug, be sure to hold the plug as you remove it. If you pull on the DC cord, you may damage the cord, resulting in fire or electric shock.
- Do not wipe the exterior with benzene or paint thinner based liquid, and do not apply insecticide near the AR-mini or the AC adapter.
- Doing so may damage the surface of the units. To clean them properly, always wipe the units with a soft, dry cloth.



Prohibition

- Do not use the AC adapter if it affects nearby televisions, electronic equipment, medical equipment, or the like.
- Before moving the unit for charging, remove the AC adapter power plug from the outlet and confirm that it has been disconnected. If this is not done, the cord may be damaged, resulting in fire or electric shock.

## IMPORTANT

- Remove the AC adapter after approximately 20 hours have passed from the start of charging. Failure to do so may result in over-charging of the batteries.
- The AR-mini and AC adapter become warm during the charging operation and immediately after charging. This is normal.
- After the charging operation ends, do not repeatedly charge the Ni-MH batteries. Doing so may overcharge the Ni-MH batteries, causing their performance to decline and shortening their service life.
- Be sure to charge the battery before using it for the first time, and after not using it for an extended length of time.

## IMPORTANT

- When you charge the Ni-MH batteries after not using them for an extended length of time, the charging operation will end before achieving full charge, resulting in insufficient charge. This happens because extended storage of the Ni-MH battery makes it difficult to charge. In such cases, if you charge and then discharge (use until the battery has no more charge) the battery two or three times in a row, the battery will again charge properly.
- Fully use up the Ni-MH batteries' charge before recharging them. If the batteries are recharged without first being fully depleted, they may not charge properly even if the charging operation is performed for a sufficient length of time. In order to prevent such problems, we recommend fully using up the batteries' charge and then recharging them at least once a month.
- The Ni-MH batteries' service life under normal use is approximately one year. If the batteries' charge depletes quickly under normal use, even when fully charged, they may be close to the end of their service life. In such cases, quickly replace the batteries with new ones.
- If the charging terminals on the Ni-MH batteries are dirty, it may not be possible to charge the battery properly. Always clean the charging terminals before charging the batteries. If the terminals become dirty, wipe them with a dry cloth.

# INTRODUCTION

## Contents List

When unpacking the AR-mini, please check that the box contains the following items.

If you find any item(s) to be missing, please contact your dealer.

- AR-mini Receiver



- Antenna



- Ni-MH Batteries

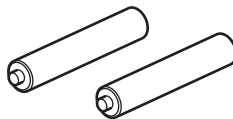

- AC Adapter (AA-mini)

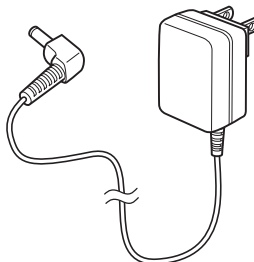

- Hand Strap

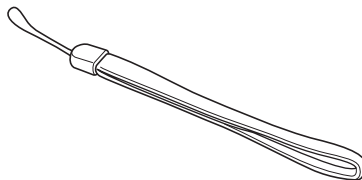

- Belt Clip (hook) with screws

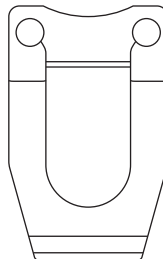

- Operating Manual





# INTRODUCTION

## Part Names and Functions

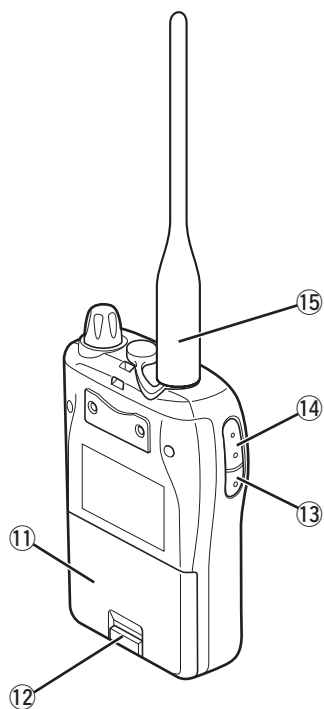
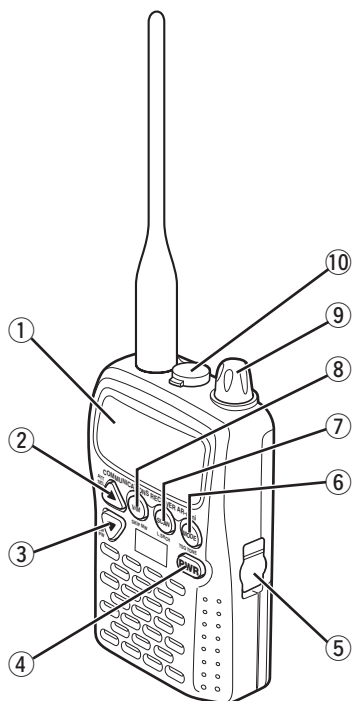

# INTRODUCTION

## ① Display

### ② ▲ (Up) key

- Press this key to increase the setting value.
- Hold down this key to set the attenuator.
- Press this key while holding down the FUNC key to set the VFO, Broadcast Facility or PRESET.
- Hold down this key together with the FUNC key to store a priority channel for PRIORITY SCAN.

### ③ ▼ (Down) key

- Press this key to decrease the setting value.
- Hold down this key to start the 2VFO watch.
- Press this key while holding down the FUNC key to start the Priority Scan.
- Hold down this key together with the FUNC key to store a channel for the 2VFO watch.

### ④ PWR key

- Press and hold this key to turn the power on or off.

### ⑤ External DC jack

- Remove the external DC jack cover and insert the DC output plug of an AA-mini or DC mini for power supply or charging.

## ⑥ MODE key

- Press this key to switch between FM, Wide FM, AM and auto modes.
- Press this key while holding down the FUNC key to select a tone type.

## ⑦ SCAN key

- Press this key to start a search in VFO, or to begin a scan in MEMORY.
- Hold down this key to search for a bug frequency.
- Press this key while holding down the FUNC key to store frequencies in the limit search operation.
- Hold down this key together with the FUNC key to change the band in the limit search operation.

## ⑧ V/M key

- Press this key to switch between VFO and MEMORY.
- Hold down this key to assign a skip channel for search or scan.
- Press this key while holding down the FUNC key to memorize a frequency and then name the memorised frequency.
- Hold down this key together with the FUNC key to erase a memory channel.

# INTRODUCTION

## ⑨ Dial knob

- Turn this knob to change the frequency or memorised channel.
- Press this knob to switch the volume or squelch settings.
- Turn this knob while holding down the FUNC key to change the frequency more quickly.
- Hold down this key together with the FUNC key to change the settings.

## ⑩ Earphone jack

- Remove the earphone jack cover and connect the earphones.

## ⑪ Battery case

- Remove the battery case lid, and install the supplied Ni-MH battery or AA battery.

## ⑫ Battery case lock

- Unlock this to remove the battery case lid.

## ⑬ MONI key

- Hold down this key to open the squelch and monitor.
- Press this key while holding down the FUNC key to lock keys other than the PWR, FUNC and MONI keys.

## ⑭ FUNC key

- Press this key together with another key or dial knob to use the function operation.

## ⑮ Antenna connector

- Fix the supplied antenna.

# INTRODUCTION

## Description of LCD (Liquid Crystal Display)

Main Display: Frequency, memory name, setting number or the other various conditions are displayed.

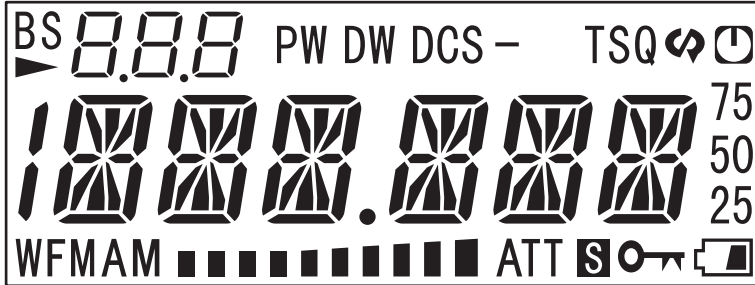

1: This segment appears when the frequency in VFO is 1000 MHz or higher.

.: Decimal point

75 50 25: This segment appears when a 6.25 and 12.5 kHz step are set.

WFM, FM, AM: FM, Wide FM, AM or AUTO appears in VFO.

■■■■■■■■: Signal meter

ATT: This segment appears when the attenuator is set.

S: This segment appears when a battery save is set.

🔑: This segment appears when the key lock is set.

🔋: Low battery indicator.

B: This segment appears when the Busy scan is active.

S: This segment is appears when Set Number is selected to change the settings.

PW: This segment appears when the Priority watch is active.

DW: This segment appears when the 2VFO watch is active.

DCS: This segment appears when Digital Code squelch is set.

—: Repeater minus

TSQ: This segment appears when Tone Squelch is set.

🌀: This segment appears when the Scrambler function is set. (Not available for the US domestic version.)

🕒: This segment appears when the off timer or alarm is set.

▶: This segment appears when the skipped frequency is set to Search.

# PREPARATION AND BASIC USAGE

## Connect the Antenna

- 1 Press the antenna firmly onto the antenna connector.

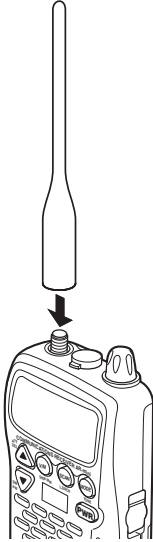

- 2 Twist the antenna clockwise.

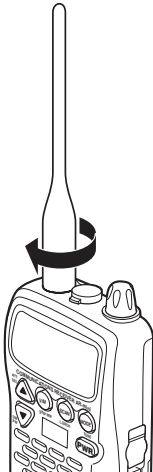

- 3 Confirm that the antenna is fixed to the AR-mini.
- 4 To remove the antenna, twist the antenna counterclockwise.

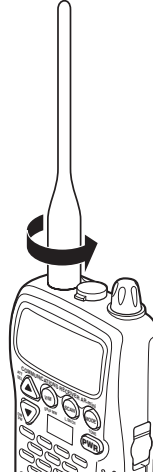

**Note:**

AR-mini has a SMA antenna connector. Never connect any other type antenna.

# PREPARATION AND BASIC USAGE

## Attach the Belt Clip

- 1 Insert the supplied screws through the screw holes of the belt clip.

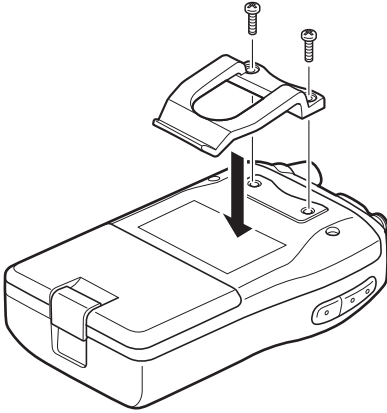

- 2 Fix the belt clip with the supplied screws.

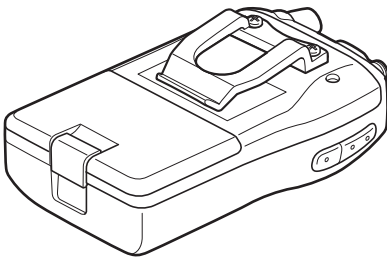

### Note:

Do not use screws other than those supplied, as the inside of the AR-mini may be damaged or the unit could easily be dropped.

## Tie the Hand Strap

- 1 Push the end of the hand strap through the hand strap holder.

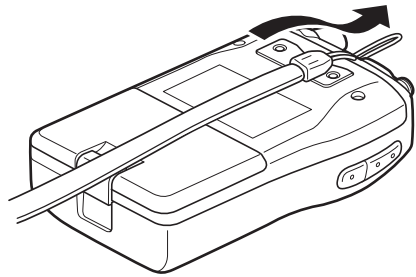

- 2 Loop the other end through the end that has just been pushed through.

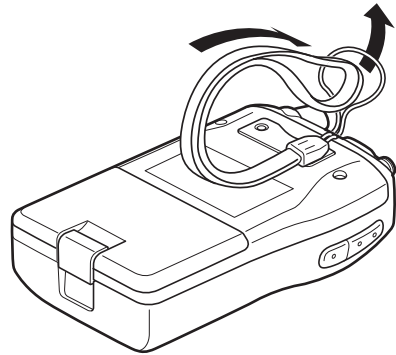

- 3 Tie the hand strap.

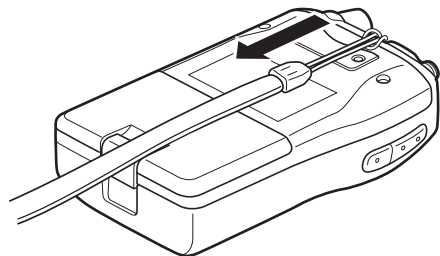

# PREPARATION AND BASIC USAGE

## Install the Supplied Ni-MH Batteries or AA Batteries

- 1** Unlock the battery case lock.

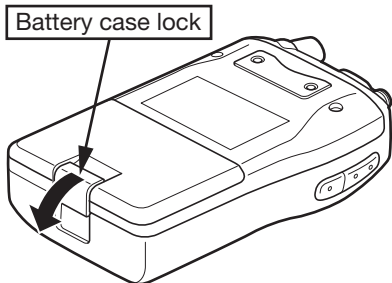

- 2** Remove the battery lid.

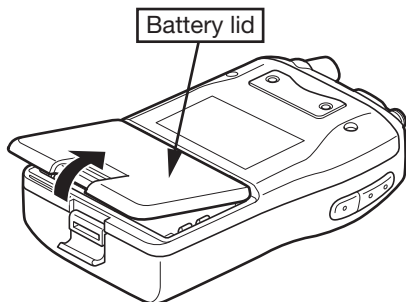

- 3** Confirm the positive and negative points of the battery.
- 4** Correctly install the battery in the battery case.

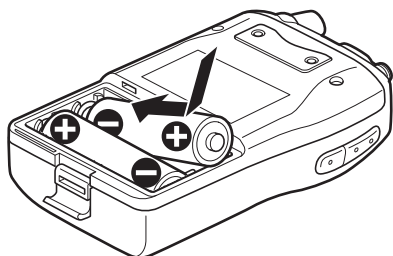

- 5** Attach the battery lid.
- 6** Lock the battery case lock.

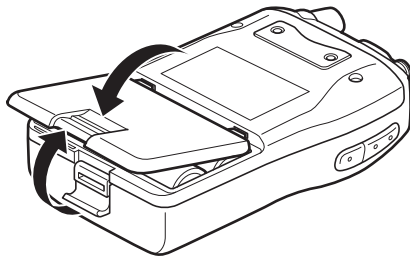

### Note:

- Never use old batteries together with new batteries.
- Never use different types of battery together.
- When disposing of old batteries, be sure to distinguish them from other waste products and observe any local rules regarding correct disposal.

# PREPARATION AND BASIC USAGE

## Charge the Supplied Ni-MH Batteries

### Caution:

Never charge any other type of battery. Attempting to charge other types (e.g. manganese or alkaline), may result in fire or explosion.

The supplied Ni-MH batteries are charged via the AA-mini AC adapter.

- 1 Turn the AR-mini off.
- 2 Make sure the AR-mini contains the supplied Ni-MH batteries.
- 3 Remove the external DC jack cover.

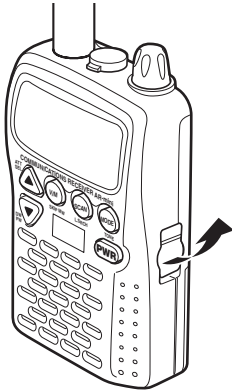

- 4 Insert the DC output plug into the external DC jack on the right side of the AR-mini.



- 5 Insert the AC adapter power plug into an AC outlet (100 V–240 V).

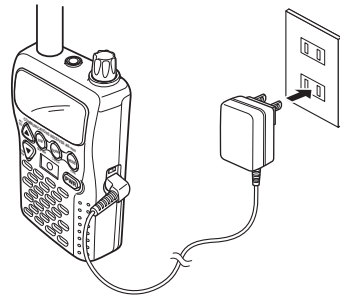

- 6 Press the PWR key to turn the power on.
- 7 Press the dial knob while holding down the FUNC key to change the setting.
- 8 Turn the dial knob to select setting number 30.
- 9 Hold down the FUNC key and turn the dial knob to set “CHARG”.
  - (  ) will blink.



# PREPARATION AND BASIC USAGE

**10** Press the dial knob to return to VFO.

**11** Approximately 20 hours later, disconnect the AC adapter from the AC outlet and then remove the DC-out plug from the AR-mini.

**Tips:**

- The charging function is cancelled when the AC adapter is disconnected.
- The charging function will be cancelled automatically after 24 hours have passed. When recharging, repeat from step 7.
- The charging function continues even if the power is turned off.

# PREPARATION AND BASIC USAGE

## Basic Usage

- 1 Press and hold the PWR key for 2 seconds or longer to turn the AR-mini on.



- 2 Confirm that WFO has appeared in the display.



(VFO)

- \* 10 MHz (AM mode) is displayed initially.
- If MEMORY appears, press the V/M key to switch to VFO.

- 3 Turn the dial knob to match the desired frequency.
  - Turn the dial knob while holding down the FUNC key; the frequency will change in 1 MHz steps.

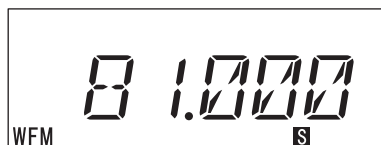

- 4 If the reception mode is different, press the MODE key until the desired reception mode is displayed.



- The reception mode will be changed with each press of the MODE key, as follows:  
AUTO → FM → WFM → AM →  
AUTO → .....

# PREPARATION AND BASIC USAGE

## Note:

The AR-mini is by default initially set to Auto step and Auto reception mode functions. These functions change the frequency step and reception mode automatically depending on the band. They can be cancelled and reset manually.

- 5** Press and turn the dial knob to adjust the volume.

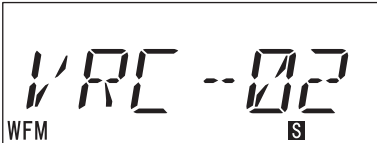

- Volume can be changed by turning the dial knob as follows:  
00 → 01 → (01) → (01) → 02 → (02) → (02) → 03 → (03) → (03) → 04 → (04) → (04) → 05 → ..... → 10

## Note:

The displayed volume value will not be changed for every 2 steps, but in reality the volume has changed.

- 6** Press the dial knob again, and the turn it to adjust the squelch.



- The squelch level can be changed by turning the dial knob as follows:
- **Increase direction (clockwise)**  
00 → 01 → (01) → 02 → (02) → 03 → (03) → 04 → (04) → 05 → (05) → 06 → 07 → 08 → 09 → 10
- **Decrease direction (anticlockwise)**  
10 → 09 → 08 → 07 → 06 → 05 → (05) → 04 → (04) → 03 → (03) → 02 → (02) → 01 → (01) → 00

## Note:

Some displayed squelch values will not be changed, but in reality the squelch level has changed.

# PREPARATION AND BASIC USAGE

## Quick Guide: Scan Frequencies Previously Saved in a Memory Bank

### Storing a frequency in memory bank

- 1 Confirm that VFO is set.
- 2 Turn the dial knob to set the frequency to be stored in memory.



- 3 Hold down the FUNC key and press the V/M key.
  - The memory bank and number will blink.
- 4 Press the ▲ or ▼ key to change the memory bank.

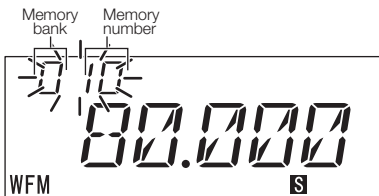

- 5 Turn the dial knob to change the memory number.
  - Skip this step if there is no need to change the memory number.
- 6 To store, hold down the FUNC key and press the V/M key.

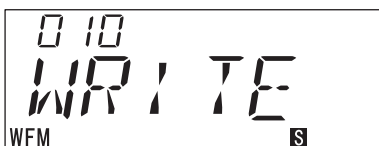

### Scanning the memory bank

Scanning can be performed within a specified memory bank.

- 1 Confirm that VFO is set.
- 2 Hold down the FUNC key and press the dial knob to change the setting.
- 3 Turn the dial knob to select setting number 09.
- 4 Hold down the FUNC key and turn the dial knob to select BANK.

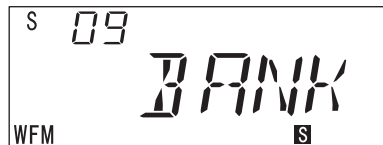

- 5 Press the dial knob or V/M key to return to VFO.
- 6 To return to MEMORY, press the V/M key.
- 7 Press the ▲ or ▼ key to select the desired memory bank.
- 8 Press the SCAN key.
  - Scanning will start in the memory bank.
- 9 To change the memory bank, hold down the FUNC key and turn the dial knob.
- 10 Press the V/M key to return to MEMORY.

# PREPARATION AND BASIC USAGE

## Options List

- AA-mini  
“A” plug type replacement AC adapter  
(6 VDC, 500mA for 100 – 240 VAC)

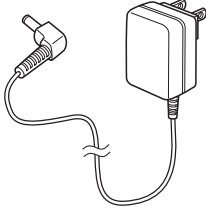

- DC-mini  
DC cable with cigar-lighter plug  
(6 VDC, 500 mA for 12/24V socket)

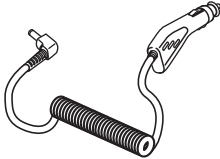

- CO-mini  
Data cloning cable  
(AR-mini to AR-mini)

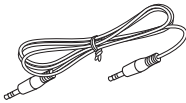

- PC-mini  
PC cable  
(USB only)

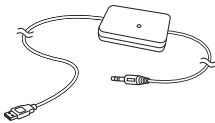

## Using the DC-mini DC Adapter

- 1** Insert the cigar lighter plug into the cigar lighter receptacle (12 or 24 VDC) of the vehicle.

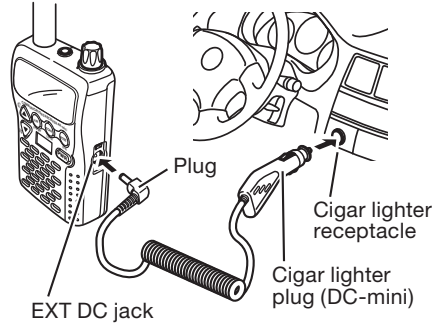

- 2** Remove the AR-mini EXT DC jack cap.
- 3** Insert the DC-mini plug into the EXT DC jack.
- 4** To charge the supplied Ni-MH battery, AR-mini's settings have to be changed.

### Note:

- Do not remove the plug by tugging at the cable. The cable may become disconnected and thereafter malfunction.
- Never use this unit with wet hands. Doing so may result in an electric shock.
- Noise that results from AR-mini being operated with this unit is not necessarily a sign of malfunction.

# PREPARATION AND BASIC USAGE

## Using the CO-mini Clone Cable

- 1 Turn the AR-mini off.

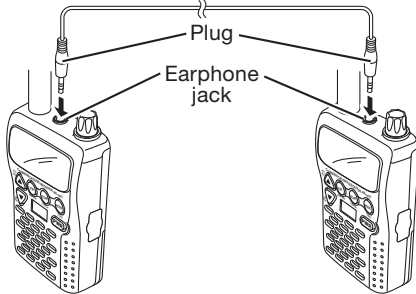

- 2 Remove the AR-mini earphone jack cap.
- 3 Turn the power on while holding down FUNC and ▲ key.
  - “RX-TX” will be displayed.
- 4 Press the receiver’s SCAN key. (“R” will be displayed.)
- 5 Press the transmitter’s MODE key. (“T” will be displayed.)
- 6 Confirm “PASS” is displayed when the cloning is completed.
  - If “NPASS” is displayed, the cloning has failed. Repeat the procedure from step 3.

### Note:

- Do not remove the plug by tugging at the cable. The cable may become disconnected and thereafter malfunction.
- Turn the power off before connecting or removing the cable.

## Using the PC-mini Programing Cable

### Preparations

#### ◆ Installing special software

- ① Access the download page on our web site and download the software according to the explanation provided there.  
URL: <http://www.aorja.com/ar-mini/>
- ② Run the downloaded file and perform setup.

#### Caution:

Although this software is provided free of charge, do not make any illegal copies.

#### ◆ Installing the USB driver

PC-mini requires a special USB driver.

Before connecting PC-mini to the PC, ensure that you have installed the USB driver.

This USB driver can be downloaded from the following URL.

URL: [http://www.aorja.com/ar-mini/CP210x\\_VCP\\_Win2K\\_XP\\_S2K3.exe](http://www.aorja.com/ar-mini/CP210x_VCP_Win2K_XP_S2K3.exe)

or

URL: <http://www.silabs.com/>

\* Download the VCP Driver kit.

# PREPARATION AND BASIC USAGE

## Connecting PC-mini

### Caution:

Check that the USB driver is properly installed before connecting PC-mini to the PC.

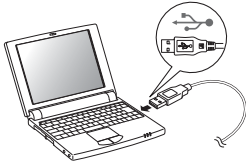

Connect PC-mini to the USB terminal of the PC.

Connect PC-mini's USB plug to the USB terminal of the PC.

### Note:

Ensure that the USB plug is properly and firmly connected to the USB terminal of the PC.

## Connecting with the AR-mini

- 1** Hold down the PWR key of the AR-mini for at least 2 seconds to turn the power off.
- 2** Hold down the PWR switch for at least 2 seconds while holding down the FUNC, ▼ and the dial knob to turn the power on.
- 3** Confirm that "PRG-M" is displayed.
  - If "PRG-M" does not appear, repeat the procedure from step 1.
- 4** Remove the AR-mini earphone cap.
- 5** Firmly insert the PC-mini 3.5  $\phi$  plug into the AR-mini jack.

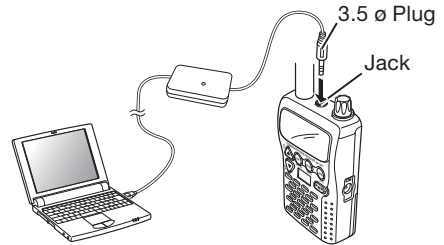

# PREPARATION AND BASIC USAGE

## Running the PC-mini program

Click and run AR-mini.exe that you have downloaded from the AOR web site.

### **Tips:**

It is recommended that you create a shortcut on your PC. This will enable you to run the program quickly on subsequent occasions.

Refer to the program software manual for instructions on using the PC-mini program software.

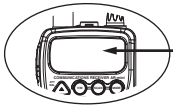

Display when reading data

PRG-R

Display when writing data

PRG-W

When operation is complete

END



# BASIC OPERATION

## Switching On

- 1 To turn the power on, press and hold the PWR key for 2 seconds or longer.
  - A switching-on beep is emitted, and the display back light will be illuminated.



- 2 To turn the power off, press and hold the PWR key for 2 seconds or longer.

- A powering-off beep will be emitted, and "BYE" displayed.

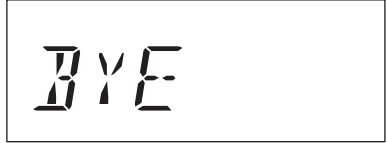

### Note:

The supplied batteries are not charged when shipped, so please charge the batteries prior to use.

# BASIC OPERATION

## Adjusting the Volume

- 1** To adjust the volume, press the dial knob.



- 2** To increase the volume, turn the dial knob clockwise.

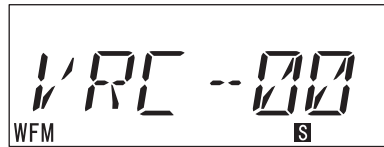

(Minimum volume level)

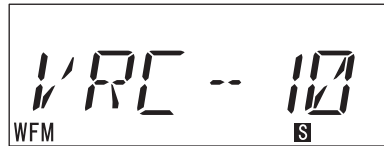

(Maximum volume level)

- 3** To decrease the volume, turn the dial knob counterclockwise.

### Note:

- Make sure the volume is not too great. Decrease the volume when switching to the earphone after using the internal speaker.
- In order to maintain safety, take special care to decrease the volume while driving or walking.

### Tips:

- Volume can be changed by turning the dial knob as follows:  
00 → 01 → (01) → 02 → (02) → (02) → 03 → (03) → (03) → 04 → (04) → (04) → 05 → ..... → 10
- The displayed volume value will not be changed for every 2 steps, but in reality the volume has changed.

# BASIC OPERATION

## Adjusting the Frequency

- 1 Confirm that VFO is set.
  - When a memory name is displayed, press the V/M key to switch to VFO.
- 2 Press the ▲ or ▼ key to set the desired band.
  - Refer to the band table on this page.



- 3 To increase the frequency, turn the dial knob clockwise.  
To decrease the frequency, turn the dial knob counterclockwise.



- 4 To change the frequency more quickly, hold down the FUNC key while turning the dial knob.



### Note:

The AR-mini is by default initially set to the Auto step function. This function changes the frequency step automatically depending on the band. It can be cancelled and reset manually.

Band range table

Displayed frequency	Band range (MHz)
0.594 (0.600*)	0.1-1.6200
6.055 (6.030*)	1.6200-51.00
51.000	51.00-76.00
82.500	76.00-108.00
128.800	108.00-142.00
145.000	142.00-170.00
175.750	170.00-336.00
370.000	336.00-430.00
433.000	430.00-470.00
649.750	470.00-770.00
903.0125	770.00-915.00
1295.000	915.00-1299.995

(\* US version)

# BASIC OPERATION

## Adjusting the Squelch

- 1** To adjust the squelch, press the dial knob twice.

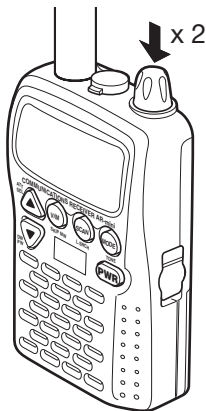

- 2** To adjust the squelch, slowly turn the dial knob clockwise.



- 3** Stop the dial knob when no noise is emitted.



- This position is called "Threshold".

- 4** To cancel the squelch temporarily, press and hold the MONI key

- The squelch will be cancelled while holding the MONI key.

### Tips:

- The squelch level can be changed by turning the dial knob as follows:  
**Increase direction (clockwise)**  
00 → 01 → (01) → 02 → (02) → 03 → (03) → 04 → (04) → 05 → (05) → 06 → 07 → 08 → 09 → 10  
**Decrease direction (anticlockwise)**  
10 → 09 → 08 → 07 → 06 → 05 → (05) → 04 → (04) → 03 → (03) → 02 → (02) → 01 → (01) → 00  
Some displayed squelch values will not be changed, but in reality the squelch level has changed.
- When the squelch volume level is set at a high level, it may become impossible to receive weak signals.

# BASIC OPERATION

## Changing the Mode

The AR-mini is by default initially set to the Auto reception mode function. This function changes the reception mode automatically depending on the band. The reception mode can be changed manually.

**1** To change the reception mode, press the **MODE** key.

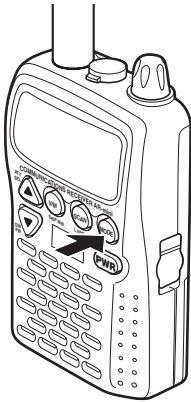

- The reception mode will be changed with each press of the **MODE** key, as follows:  
AUTO → FM → WFM → AM →  
AUTO → .....

## Monitoring

**1** To monitor, press the **MONI** key.



- Voice may be received with noise.
  - Even if a tone squelch or DCS is set, it can be cancelled by pressing **MONI** key.
- Refer to the tone squelch details on page 46, and the DCS explanation on page 72.

# BASIC OPERATION

## Setting the AR-mini

The AR-mini has the following settings for easy reception of desired frequencies.

**VFO:** This is the default AR-mini setting. In this setting, frequencies are set directly by turning the dial knob.

**MEMORY:** Frequencies can be stored in the memory with specific names. Recall the memory to receive the desired frequency.

**PRESET:** Some frequencies can be stored as preset numbers. You can receive the desired frequency via PRESET.

**1** To set MEMORY from VFO, press the V/M key.



**2** Press the V/M key to return to VFO from MEMORY.

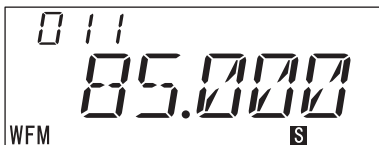

**3** To switch to PRESET from VFO, hold down the FUNC key and press the ▲ key.

- These settings are categorised as Broadcast Facility, PRESET and VFO.

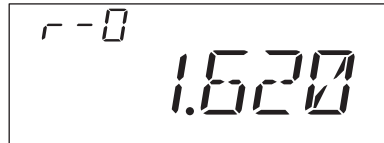

(PRESET)

- Hold down the FUNC key and press the ▲ key.

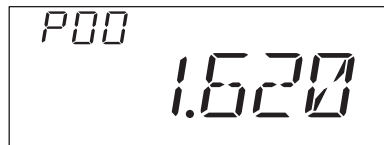

(Broadcast Facility)

- Hold down the FUNC key and press the ▲ key.



VFO

### Tips:

When there is no memory stored in step 1, a low pitch tone beep will be emitted.

# ADVANCED OPERATION

## Finding the Desired Frequency

AR-mini has the following functions for finding desired frequencies:

Priority watch, 2VFO Watch, Search and Memory scan.

### ◆ Priority Watch

In this function, the frequency received in VFO will be switched to another priority frequency every 5 seconds.

### ◆ 2VFO Watch

Two frequencies are stored in the 2VFO Watch memory in VFO. Each frequency is watched, and then either frequency is received, the 2VFO Watch is paused while receiving.

### ◆ Search

In search, the receiver consecutively monitors all frequencies between two frequency limits.

There are three search methods; VFO search, limit search and limit link search.

### ◆ Memory Scan

In scan, the receiver tunes through stored memory channels (spot frequencies).

## Priority Watch

In this function, the frequency received in VFO will be switched to another priority frequency every 5 seconds. This function is available in VFO.

- 1 Confirm that VFO is set.
- 2 Turn the dial knob to set a frequency to be received as the priority frequency.

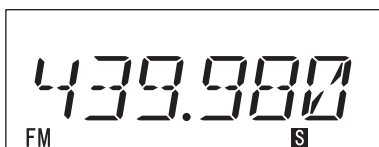

- 3 To store the priority frequency in the Priority Watch memory, hold down the FUNC key and press the ▲ key for 2 seconds or longer.
  - "PWM W" will be displayed.

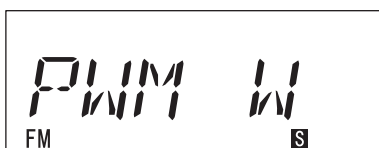

- Tune to your desired frequency.
- 4 Hold down the FUNC key and press the ▼ key.
    - Priority scan will begin.

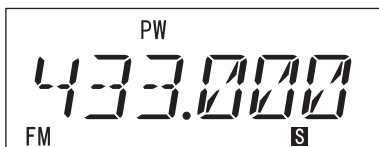

- 5 To cancel the Priority Watch, press the V/M key.

# ADVANCED OPERATION

## 2VFO Watch

Two frequencies are stored in the 2VFO Watch memory in VFO. Each frequency is watched, and then either frequency can be received, the 2VFO Watch will be paused while receiving.

- 1 Confirm that VFO is set.
- 2 Turn the dial knob to set a frequency to be stored as the 2VFO Watch memory A.

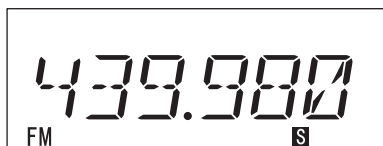

- 3 To store the frequency in the 2VFO Watch memory, hold down the FUNC key and press the ▼ key for 2 seconds or longer.
  - “DWA W” will be displayed.



- 4 Turn the dial knob to set another frequency to be stored as the 2VFO Watch memory B.

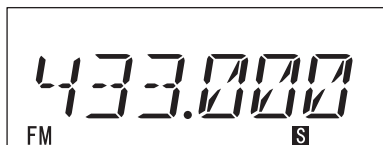

- 5 To store the frequency in the 2VFO Watch memory, hold down the FUNC key and press the ▼ key for 2 seconds or longer.
  - “DWB W” will be displayed.

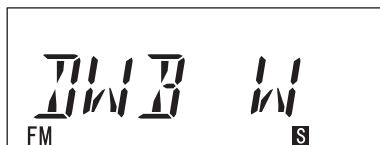

- 6 Press the ▼ key for 2 seconds or longer to start the 2VFO Watch.

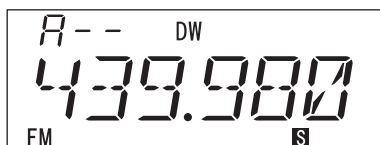

- 7 To cancel the 2VFO Watch press the V/M key.



# ADVANCED OPERATION

## 2VFO Watch with 2VFO Watch Reception Memory

10 combinations of frequency are set beforehand as the 2VFO Watch Reception Memory. The 2VFO Watch can be started from this memory.

- 1 Confirm that VFO is set.
- 2 Press the ▼ key for 2 seconds or longer to start the 2VFO Watch.
  - The 2VFO Watch which is set previously will be started.
- 3 Turn the dial knob while holding down the FUNC key to select the number of the 2VFO Watch Reception Memory.
  - The 2VFO Watch will start between the selected 2VFO Watch Reception Memory.

### Tips:

2VFO Watch Reception Memories are listed on page 74.

## Changing the 2VFO Watch Reception Memory

The 2VFO watch Reception Memory can be changed.

- 1 Start a normal 2VFO Watch.
  - Refer to “2VFO Watch” on page 32.
- 2 Hold down the FUNC key and press the ▼ key for 2 seconds or longer.
- 3 Turn the dial knob while holding down the FUNC key to select the number of the 2VFO Watch Reception Memory.



- 4 To store, hold down the FUNC key and press the ▼ key for 2 seconds or longer.

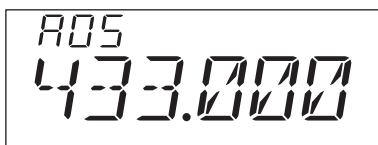

# ADVANCED OPERATION

## VFO Search

VFO search consecutively monitors all frequencies from 0.1 MHz to 1299.995 MHz.

- 1 Confirm that VFO is set.
- 2 Hold down the FUNC key and press the dial knob to change the setting.
- 3 Turn the dial knob to select setting number 08.

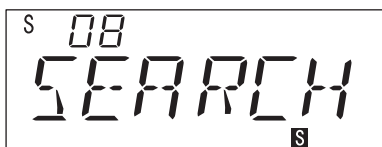

- 4 Hold down the FUNC key and turn the dial knob to select VFO.
  - "VFO" will be displayed initially.



- 5 Press the dial knob to return to the VFO.
- 6 Press the SCAN.
- 7 To start the VFO search, press the scan key.



- When VFO search is paused, the decimal point will blink.

- 8 To cancel VFO search, press the V/M key or dial knob.

## Skipping the Desired Frequency in a Search

A frequency can be skipped in a search. This prevents a search from being stopped when a frequency that should be cancelled is received. As many as 100 skipped frequencies can be stored.

- 1 Press the SCAN key to start the search.
- 2 Press the V/M key for 2 seconds or longer when the search is paused on the frequency to be skipped.
  - The skip memory number is displayed.

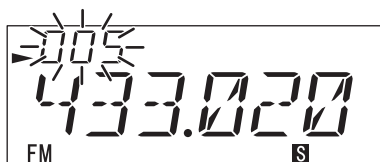

- 3 Turn the dial knob to change the skip memory number.
  - This step can be skipped, but the skip memory number will not change.
- 4 To store frequencies in the skip memory, press the V/M key for 2 seconds or longer.
- 5 Repeat steps 2 through 4 to store other frequencies in the skip memory.
  - As many as 100 frequencies can be stored.

### Tips:

- In VFO, frequencies can be stored in the skip memory through the same procedure.
- Skip memory can be returned to normal memory (refer to "Erasing VFO Skip Memory" on page 60).

# ADVANCED OPERATION

## Limit Search

This enables searches to be conducted within a desired limited range.

- 1 Confirm that VFO is set.
- 2 Hold down the FUNC key and press the dial knob to change the setting.
- 3 Turn the dial knob to select setting number 08.

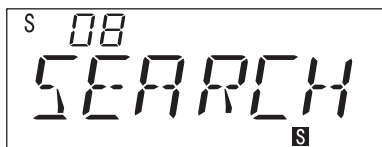

- 4 Hold down the FUNC key and turn the dial knob to select LIMIT.
  - "VFO" will be displayed initially.

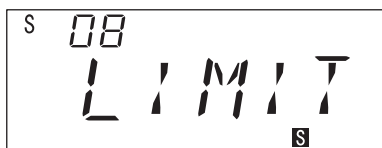

- The limit search is set.

- 5 To return to VFO, press the dial knob or V/M key.
- 6 Turn the dial knob to set a lower frequency of limit range.
- 7 Hold down the FUNC key and press the SCAN key.
  - "SCHA W" will be displayed and VFO will be returned to.
- 8 Turn the dial knob to set an upper frequency of limit range.

- 9 Hold down the FUNC key and press the SCAN key.
  - "SCHB W" will be displayed and VFO will be returned to.
- 10 Press the SCAN key to start the Limit Search.

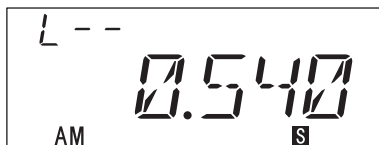

- 11 To cancel a Limit search, press the V/M key or dial knob.

### Tips:

Limit search memory can be called by holding down the FUNC key and turning the dial knob during a limit search.

# ADVANCED OPERATION

## Changing the Search Type

The AR-mini has three searching method types. These can be changed when searching.

**1** Start a search.

**2** Press the SCAN key to change the scan type.

- The scan type will be changed with each press of the SCAN key, as follows:

Busy Search → Hold Search →

Time Search → Busy Search → .....

- Busy Search: the “B” icon is lit. The search will be paused while receiving a signal. The search will resume 2 seconds later when the signal is gone.
- Hold Search: the “B” icon is blinking. The search will be stopped when a signal is received.
- Time Search: No icon is displayed. The search will be paused for 5 seconds when a signal is received. The search will resume 5 seconds later even if a signal is received. If the signal disappears during the 5 seconds pause period, the search will be resumed 2 seconds later. This pause length can be changed by setting number 07.

## Changing the Search Band Memory

The search band memory is preset when the AR-mini is shipped. The frequency of search band memory can be changed.

**1** Start a limit search.

**2** Hold down the FUNC key and turn the dial knob to select the memory number to be memorised.

**3** Hold down the FUNC key and press the SCAN key for 2 seconds or longer.

### Tips:

The search band memories are listed on page 74.

# ADVANCED OPERATION

## Limit Link Search

This enables a Linked Limit Search for easy change of limit ranges.

- 1 Confirm that VFO is set.
- 2 Hold down the FUNC key and press the dial knob to change the setting.
- 3 Turn the dial knob to select setting number 08.

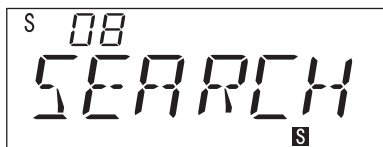

- 4 Hold down the FUNC key and turn the dial knob to select "LTLNK".



- 5 Turn the dial knob to select setting number 10.

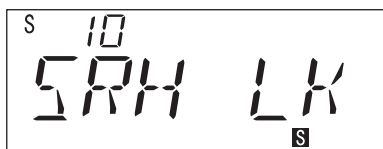

- 6 Hold down the FUNC key and turn the dial knob to select the pattern number (0 to 9) into which you want to set the Search Band Memory numbers (L00 to L22, refer to the list p.74)

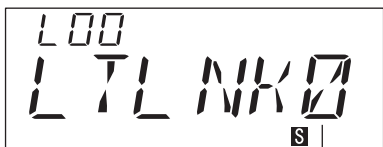

- 7 Hold down the FUNC key and turn the dial knob to select the search band memory number (0 to 22) to be linked.



- 8 Turn the dial knob to select or deselect the link number.
  - A decimal point will be displayed when the link number is selected.
  - Beware that by default all link numbers from 00 to 22 are selected. Unselect the numbers you don't need in your scan.

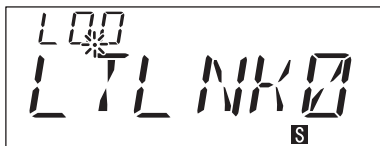

- 9 Hold down the FUNC key and turn the dial knob to select the next limit search number to be linked.
  - Repeat steps 8 and 9 as many times as necessary.

- 10 To return to VFO, press the dial knob twice or V/M key twice.

- 11 Press the SCAN key to start a Limit Link Search.

- 12 Press the V/M key to stop the Limit Link Search.

# ADVANCED OPERATION

## Example:

The limit search memory 00 is set from 118.00 to 141.975 MHz.

The limit search memory 01 is set from 154.95 to 154.61 MHz.

When the memory 00 is linked to memory 01, the search range is set as follows:

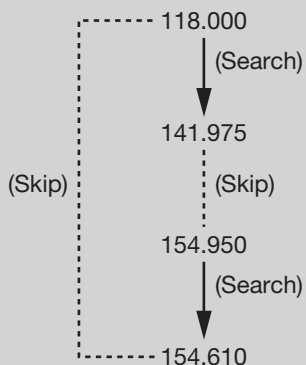

## MEMORY

As many as 1000 frequencies can be stored in the memory. Memory data is banked in blocks of 100.

Memory can be stored according to memory name, tone squelch or other statuses.

The memory is used for memory scan.

### Tips:

Some shortwave broadcast station frequencies are memorised (refer to page 72 for details).

# ADVANCED OPERATION

## Storing a Frequency in Memory

- 1 Confirm that VFO is set.
- 2 Turn the dial knob to set the frequency to be stored in memory.



- 3 Hold down the FUNC key and press the V/M key.
  - The memory number will blink.
- 4 Press the ▲ or ▼ key to change the memory bank.
- 5 Turn the dial knob to change the memory number.
  - Skip this step if there is no need to change the memory number.

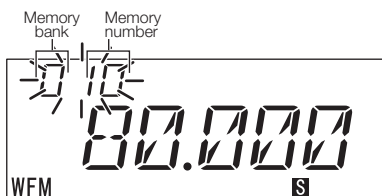

- 6 To store, hold down the FUNC key and press the V/M key.

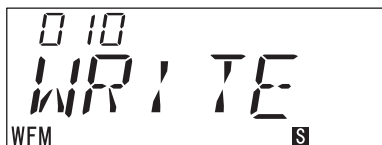

### Tips:

In step 3, press only the V/M key to cancel and return to VFO.

## Recalling Memory

- 1 Confirm that VFO is set.
- 2 Press the V/M key to set MEMORY.
- 3 Press the ▲ / ▼ key or turn the dial knob to recall the desired memory.

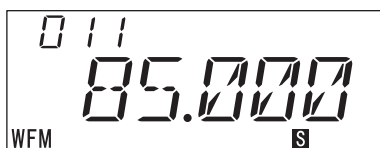

- 4 To return to the original VFO, press the V/M key.

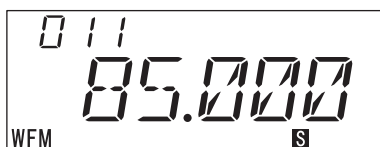

# ADVANCED OPERATION

## Returning to VFO with Displaying Memory Frequency

- 1 Confirm that VFO is set.
- 2 Press the V/M key to set MEMORY.
- 3 Press the ▲ / ▼ key or turn the dial knob to recall the desired memory.



- 4 Press the ▲ and ▼ key simultaneously to return to the VFO with displaying memory frequency.

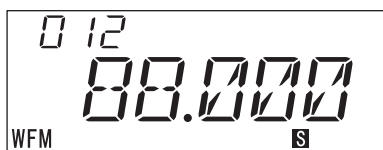

## Erasing Memory

- 1 Confirm that the MEMORY is set.
- 2 Turn the dial knob to recall the memory you wish to erase.
- 3 Hold down the FUNC key and press the V/M key.
  - "CLEAR" will be displayed.

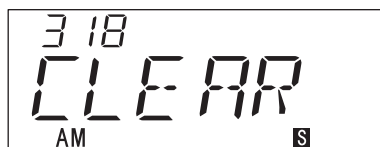

- 4 To erase the memory, hold down the FUNC key and press the V/M key.
  - The memory will be erased and MEMORY will be returned to.

### Tips:

In step 3, press only the V/M key to cancel and return to MEMORY.



# ADVANCED OPERATION

## Erasing All Memories from the Memory Bank

All memory stored in the same memory bank can be erased simultaneously.

- 1 Confirm that VFO is set.
- 2 Hold down the FUNC key and press the dial knob to change the setting.
- 3 Turn the dial knob to select setting number 13.

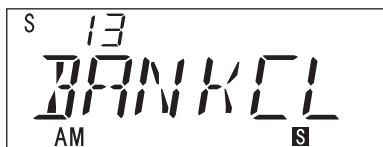

- 4 Hold down the FUNC key and turn the dial knob to select "CLEAR".
  - Release the FUNC key to select.

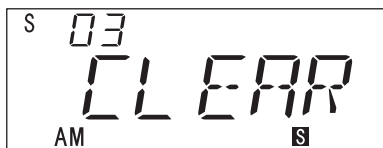

- 5 Use the dial knob to select the bank number to be erased.
- 6 Hold down the FUNC key and press the V/M key.

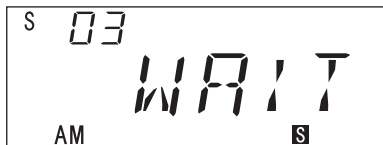

- "WAIT" will be displayed for 2 seconds, and the memory bank will then be erased.

- Memory stored in the same memory bank will be erased, and the next memory bank number will be displayed.
  - If you wish to cancel this procedure, press the V/M key to exit.
- 7 Repeat from step 4 when erasing other memory.
  - 8 Press the dial knob to return step 3.
  - 9 To return to the original VFO, press the dial knob or V/M key.

# ADVANCED OPERATION

## Naming Memory

Memory can be named using up to 6 characters.

- 1 Confirm that MEMORY is set.
- 2 Turn the dial knob to recall the desired memory to be named.
- 3 Hold down the FUNC key and press the SCAN key.
  - The cursor will blink.
- 4 Turn the dial knob to select a character.
- 5 To change the cursor, hold down the FUNC key and turn the dial knob.



- 6 To store a name, hold down the FUNC key and press the V/M key.

### Tips:

- To change the character, repeat steps 1 through 3, hold down the FUNC key and turn the dial knob to select the character to be changed. Turn the dial knob to select a new character and then hold down the FUNC key and press the V/M key.
- To check which frequency is stored under the displayed name:
  - Hold down the FUNC key and press the SCAN key.
  - Press the MODE key.To revert to NAME display, press the DIAL knob.

## Memory Scanning

How to scan all memories.

- 1 Confirm that VFO is set.
- 2 Hold down the FUNC key and press the dial knob to change the setting.
- 3 Turn the dial knob to select setting number 09.

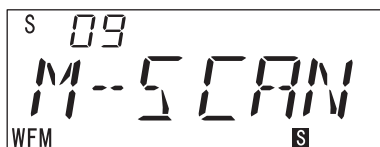

- 4 Hold down the FUNC key and turn the dial knob to select ALL.
- 5 To return to the original VFO, press the dial knob or V/M key.
- 6 Press the V/M key to enter MEMORY.
- 7 Press the SCAN key to start Memory Scan.
- 8 Press the V/M key to return to MEMORY.

# ADVANCED OPERATION

## Setting Skipped Memory when Scanning

Specified memory can be skipped when scanning. This prevents a scan from being stopped when a frequency that should be cancelled is scanned. All memory can be set as skipped memory.

- 1 Confirm that MEMORY is set.
- 2 Turn the dial knob to select the memory number to be skipped.
- 3 Hold down the V/M key for 2 seconds or longer to be set.
  - The skip memory mark (▶) will be displayed.



### Tips:

To return to the normal memory, hold down the V/M key for 2 seconds or longer in step 4.

## Scanning the Memory Bank

Scanning can be performed within a specified memory bank.

- 1 Confirm that VFO is set.
- 2 Hold down the FUNC key and press the dial knob to change the setting.
- 3 Turn the dial knob to select setting number 09.
- 4 Hold down the FUNC key and turn the dial knob to select BANK.

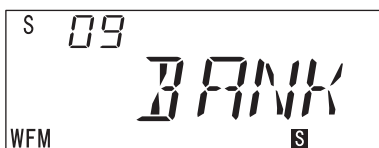

- 5 Press the dial knob or V/M key to return to VFO.
- 6 To return to MEMORY, press the V/M key.
- 7 Press the ▲ or ▼ key to select the desired memory bank.
- 8 Press the SCAN key.
  - Scanning will start in the memory bank.
- 9 To change the memory bank, hold down the FUNC key and turn the dial knob.
- 10 Press the V/M key to return to MEMORY.

# ADVANCED OPERATION

## Scanning a Linked Memory Bank

A memory bank can be linked to other memory banks to scanning.

\* The AR-mini has 10 memory banks (0 – 9).

- 1 Confirm that VFO is set.
- 2 Hold down the FUNC key and press the dial knob to change the setting.
- 3 Turn the dial knob to select setting number 09.
- 4 Hold down the FUNC key and turn the dial knob to select BKLNK.
  - “ALL” will be displayed initially.

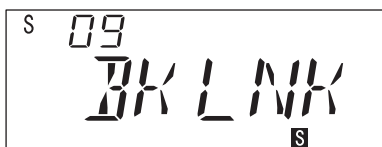

- 5 Turn the dial knob to select setting number 11.
- 6 Hold down the FUNC key and turn the dial knob to select the pattern number (0 to 9) into which you want to set the memory banks to be linked.

memory bank number

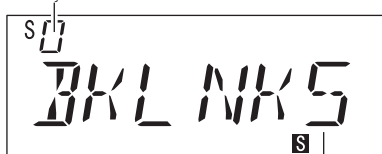

pattern number

- 7 Release the FUNC key.

- 8 Turn the dial knob to select or deselect a memory bank.
  - All memory banks are selected by default! You need to deselect the banks you don't need to scan.



- 9 Hold down the FUNC key and turn the dial knob to select another memory bank number to be linked.
- 10 Release the FUNC key.
- 11 Turn the dial knob to select or deselect a memory bank.

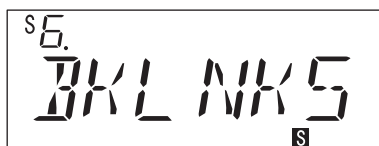

- 12 Press the dial knob.
- 13 Press the V/M key twice.
- 14 Press the SCAN key to start scanning.
- 15 Press the V/M key to stop scanning.

# ADVANCED OPERATION

## Using Broadcast Facility

This feature is used for easy tuning of various pre-programmed 'broadcast' bands (e.g. AM & FM radio stations and TV sound).

- 1 Confirm that VFO is set.
- 2 Hold down the FUNC key and press the ▲ key to display the broadcast radio memory number.
- 3 Press the ▲ or ▼ key to change the Broadcast Facility memory number.

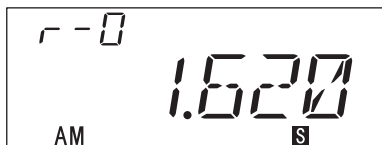

- 4 Turn the dial knob to change the frequency from preset channels.
- 5 To return to VFO, hold down the FUNC key and press the ▲ key twice.

### Tips:

- In step 3, a frequency is modified only within the specific range. This range is depending on each band.
- The memorised broadcast facility frequencies are listed on page 70.

## Using PRESET

12 frequencies are set as Preset Channel. These frequencies are typical frequencies from each band.

- 1 Confirm that VFO is set.
- 2 Hold down the FUNC key and press the ▲ key twice to display the Preset Number.

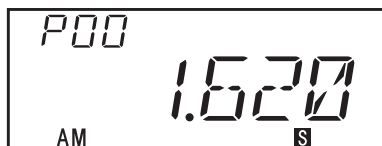

- 3 Press the ▲ or ▼ key to change the Preset Number.
- 4 To change the frequency from Preset Channel, turn the dial knob.
- 5 To return to VFO, hold down the FUNC key and press the ▲ key.

### Tips:

- Preset Number 12 is selected from among memory numbers 980 to 999.
- Turn the dial knob to go through channels of preset number 12.
- Preset frequencies are listed on page 71.

# ADVANCED OPERATION

## Using Tone Squelch (CTCSS)

A tone squelch is a setting that prevents the frequency from opening unless a proper tone frequency is received on the audio signal. There are 50 selectable tone frequencies.

- 1 Confirm that VFO is set.
- 2 Hold down the FUNC key and press the MODE key twice until TSQ is displayed.
- 3 Press the V/M key or dial knob.
  - “TSQ” tone squelch icon will be displayed.
- 4 Hold down the FUNC key and press the dial knob to change the setting.
- 5 Turn the dial knob to select setting number 20.
- 6 Hold down the FUNC key and turn the dial knob to select the tone frequency.
- 7 To return to the original display, press the dial knob or V/M key.
- 8 To cancel, press the FUNC and MODE keys several times until VFO is selected. Press the dial knob or V/M key.

### Tips:

- When AM or Wide FM is set, the tone squelch is cancelled even if the tone squelch icon is displayed.
- Tone frequencies are listed on page 73.

## Searching the Tone Frequency

This is how to find out the tone frequency of a CTCSS signal.

- 1 Confirm that VFO is set.
- 2 Turn the dial knob to set the frequency to be searched.
- 3 Hold down the FUNC key and press the MODE key several times until “TONSRH” is displayed.
- 4 Press the V/M key or dial knob.
  - The “TSQ” tone squelch icon will blink.
  - The tone frequency will be displayed when the frequency is matched.

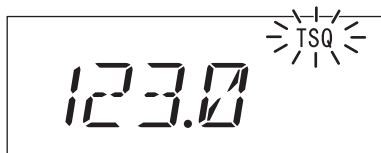

- When no tone frequency is matched, “NO TONE” will be displayed and “TSQ” will blink.

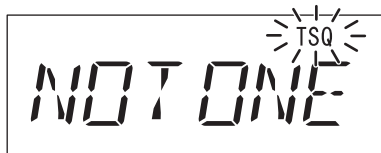

- 5 To cancel, press the FUNC and MODE key (several times) until VFO is selected. Press the dial knob or V/M key.

### Tips:

A tone frequency may be displayed as noise when the tone squelch is set to “00” or the MONI key is pressed, even if the AR-mini is receiving no signal. This is not a malfunction. We recommend that the tone squelch should be set when this function is used.

# ADVANCED OPERATION

## Reversed Tone Squelch Function

This facility reverses operation of 'tone squelch'.

It is used when special radio systems are employing mixed tones with no voice. When enabled, the squelch will cancel when normal speech is transmitted (the squelch will open so you can hear people talking) and mute when the tone signal is transmitted.

- 1 Confirm that VFO is set.
- 2 Hold down the FUNC key and press the MODE key several times until REV TSQ is displayed.
- 3 Press the V/M key or dial knob.
  - "T" icon will be displayed.



- 4 Hold down the FUNC key and press the dial knob to change the setting.
- 5 Turn the dial knob to select setting number 21.
- 6 Turn the dial knob to select REVTSQ.
- 7 Press the FUNC key and turn the dial knob to select the tone frequency.
- 8 To return to VFO, press the dial knob or V/M key.
- 9 To cancel, press the FUNC and MODE keys several times until VFO is selected. Press the dial knob or V/M key.

## Using DCS

DCS (Digital Code Squelch) is set to receive a signal which has been set by the DCS. The DCS code can be set to one of 104 codes.

- 1 Confirm that VFO is set.
- 2 Hold down the FUNC key and press the MODE key until DCS is displayed.
- 3 Press the V/M key or dial knob.
  - "DCS" icon is displayed.
- 4 Hold down the FUNC key and press the dial knob to change the setting.
- 5 Turn the dial knob to select setting number 25.
- 6 Hold down the FUNC key and turn the dial knob to select a DCS code.
- 7 To return the original display, press the dial knob or V/M key.
- 8 To cancel, press the FUNC and MODE keys several times until VFO is selected. Press the dial knob or V/M key.

### Tips:

When AM or Wide FM is set, the tone squelch will be cancelled even if the tone squelch icon is displayed. Tone frequencies are listed on page 73.

# ADVANCED OPERATION

## Using the Voice Inverter

(Not available for US domestic version)

- 1 Confirm that VFO is set.
- 2 Turn the dial knob to set the frequency to use the voice inverter.
- 3 Hold down the FUNC key and press the MODE key until V.INV is displayed.

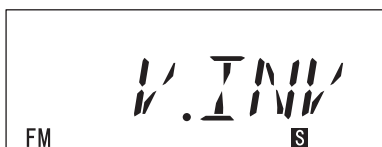

- 4 Press the dial knob.
  - The voice inverter icon will be displayed along with a voice inverter carrier frequency.

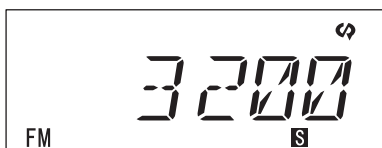

- 5 Turn the dial knob to hear the voice clearly.
- 6 To cancel, press the FUNC and MODE keys several times until VFO is selected. Press the dial knob or V/M key.

### Tips:

In step 5, the frequency is displayed by pressing the MODE key.

## Using the Attenuator

This function decreases the signal strength by 15 dB.

- 1 Confirm that VFO is set.
- 2 Hold down the ▲ key for 2 seconds or longer.
  - "ATT" icon is displayed.



- 3 To cancel, hold down the ▲ key for 2 seconds or longer.
  - "ATT" icon disappears.

## Using Key Lock

This function prevents settings from being changed by accidentally pressing keys.

- 1 Confirm that VFO is set.
- 2 Hold down the FUNC key and press the MONI key.
  - "O" (Key lock) icon is displayed.



- Except for the FUNC, MONI and PWR keys, no keys will work while "O" is displayed.
- 3 To cancel, hold down the FUNC key and press the MONI key.
    - "O" icon disappears.



# ADVANCED OPERATION

## Searching Bug Frequencies

How to scan the 119 pre-installed (unmodifiable) bug frequencies.

- 1 Confirm that VFO is set.
- 2 Hold down the SCAN key for 2 seconds or longer.
  - “t” icon will displayed.



- When a strong signal is found, it will be displayed.
- Up to 20 received frequency signals can be memorised. These can be confirmed by turning the dial knob.
- When no signal is found, “NON” will be displayed.



- 3 To cancel, press the V/M key or dial knob.
- 4 To return to VFO, press the dial knob or V/M key.

### Tips:

- For ease of use, select setting numbers 04 (S-meter Sensitivity) and 05 (S-meter Buzzer).
- The searching bug frequencies are listed on page 70.

## Using the Bug Detector Function

This function indicates signal strength via a beep tone.

- 1 Search the bug frequency as described in “Searching Bug Frequencies”.
- 2 Recall the memorised bug frequency by turning the dial knob.

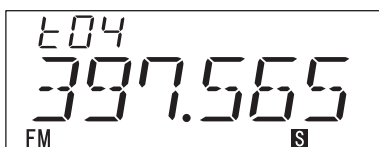

- 3 Hold down the FUNC key and press the SCAN key for 2 seconds or longer.



- S-meter sensitivity is set to low and the attenuator function is set.
- 4 Press the V/M key to return to displaying the bug frequency.
  - 5 To return to VFO, press the dial knob or V/M key.

### Tips:

In step 3 the beep tone is changed as follows:  
Slow pitch beep: Weak signal  
Middle pitch beep: Medium strength signal  
Fast pitch beep: Strong signal

# ADVANCED OPERATION

## Resetting System (System Reset)

System Reset initialises all settings except for the normal memory and skip memory.

- 1** Turn the power off.
- 2** Hold down the FUNC and MONI key and turn the power on.
- 3** Confirm that “SYSRST” is blinking.

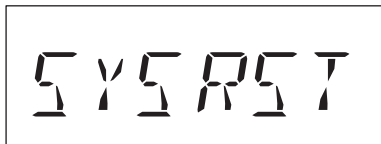
A rectangular LCD display showing the text "SYSRST" in a seven-segment font. The characters are white on a black background.

- 4** To reset the system, press and hold the dial knob for 2 seconds or longer.
  - System Reset can be cancelled by pressing the V/M key, and VFO will then be displayed.

## Resetting All Contents (All Reset)

All Reset initialises all of the AR-mini's contents.

- 1** Turn the power off.
- 2** Hold down the FUNC, MONI key and dial knob and turn the power on.
- 3** Confirm that “ALLRST” is blinking.

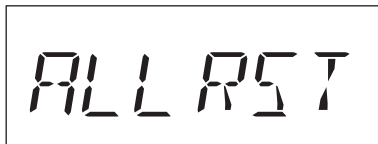
A rectangular LCD display showing the text "ALLRST" in a seven-segment font. The characters are white on a black background.

- 4** To reset all contents, press and hold the dial knob for 2 seconds or longer.
  - All Reset can be cancelled by pressing the V/M key, and VFO will then be displayed.

# CHANGING SETTINGS

## Changing Steps

This setting is used when changing the step. Initially, a step is set automatically depending on each band.

- 1 Hold down the FUNC key and press the dial knob to change the setting.
- 2 Turn the dial knob to select setting number 00.

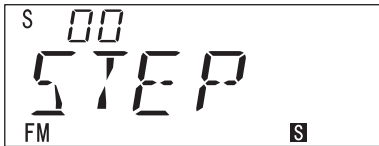

- 3 Hold down the FUNC key and turn the dial knob to select the desired step.



- 4 To return to the original display, press the dial knob or V/M key.

### Tips:

A 9 kHz step can be set only in AM mode. An 8.33 kHz step can be set in the air traffic control band.

## Changing Fast Steps

This setting is used when changing the fast step. The fast step is available by holding down the FUNC key and turning the dial knob.

- 1 Hold down the FUNC key and press the dial knob to change the setting.
- 2 Turn the dial knob to select setting number 01.

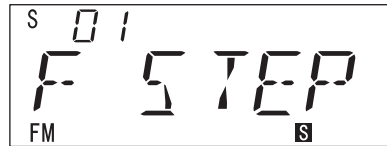

- 3 Hold down the FUNC key and turn the dial knob to select the desired fast step.

- The fast step can be set as follows: 10 kHz, 100 kHz, 1 MHz, 10 MHz and 100 MHz. (The default setting is 1 MHz.)

- 4 To return to the original display, press the dial knob or V/M key.

# CHANGING SETTINGS

## Setting the Lamp Function

This setting is used for setting the time during which the lamp should be lit.

- 1 Hold down the FUNC key and press the dial knob to change the setting.
- 2 Turn the dial knob to select setting number 02.



- 3 Hold down the FUNC key and turn the dial knob to select AUTO, OFF or ON.
  - When AUTO is selected, the lamp will be turned off 5 seconds after the key operation.
  - When OFF is selected, the lamp will be turned off even if the key is operated.
  - When ON is selected, the lamp will be constantly illuminated
- 4 To return to the original display, press the dial knob or V/M key.

### Tips:

We recommended that you select AUTO to prevent excessive battery consumption.

## Setting the Timer

This setting is used for setting the alarm time or power off time.

- 1 Hold down the FUNC key and press the dial knob to change the setting.
- 2 Turn the dial knob to select setting number 03.



- 3 Hold down the FUNC key and turn the dial knob to set.

(Refer to the below for details.)

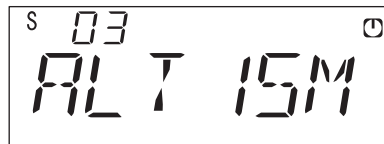
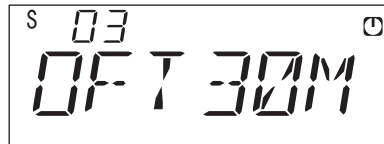

# CHANGING SETTINGS



- The off timer and alarm time can be set as follows:
  - OFT 30M: Turns off after 30 minutes
  - OFT 60M: Turns off after 60 minutes
  - OFT 90M: Turns off after 90 minutes
  - ALT 15M: Sets the alarm for 15 minutes' time
  - ALT 30M: Sets the alarm for 30 minutes' time
  - ALT 45M: Sets the alarm for 45 minutes' time
  - ALT 60M: Sets the alarm for 60 minutes' time
  - OFT: ALL off

- 4** To return to the original display, press the dial knob or V/M key.

## Setting the S-meter Sensitivity

This setting is used for reducing S-meter sensitivity.

- 1** Hold down the FUNC key and press the dial knob to change the setting.
- 2** Turn the dial knob to select setting number 04.



- 3** Hold down the FUNC key and turn the dial knob to set "LOW".

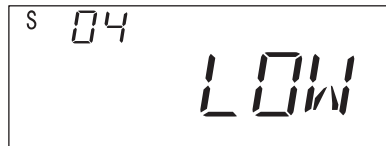
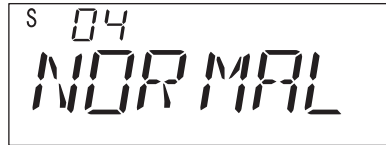

- 4** To return to the original display, press the dial knob or V/M key.

### Tips:

This function is unavailable in AM and Wide FM. This setting is useful when searching a bug frequency with the S-meter buzzer function.

# CHANGING SETTINGS

## Setting the S-meter Buzzer

This setting is used for emitting a beep sound as the S-meter's value.

- 1 Hold down the FUNC key and press the dial knob to change the setting.
- 2 Turn the dial knob to select setting number 05.



- 3 Hold down the FUNC key and turn the dial knob to set "SMBUZ".

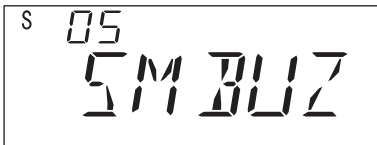

- 4 To return to the original display, press the dial knob or V/M key.

### Tips:

This setting is unavailable in AM and Wide FM. This setting is useful when searching a bug frequency with the S-meter sensitivity function

## Setting the Resumption Time

This setting is used for setting the resumption time when searching or scanning.

- 1 Hold down the FUNC key and press the dial knob to change the setting.
- 2 Turn the dial knob to select setting number 07.

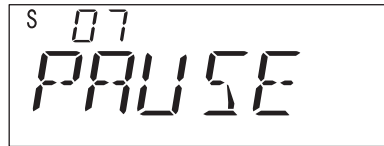

- 3 Hold down the FUNC key and turn the dial knob to set the resume time.

- The resumption time can be set at 1 to 12 seconds.

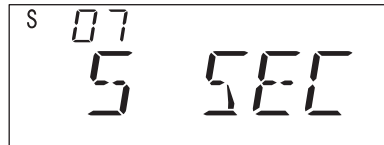

- 4 To return to the original display, press the dial knob or V/M key.

### Tips:

This setting is effective when performing a search, scan, Priority Watch or 2VFO watch.

# CHANGING SETTINGS

## Setting the Search

This setting is used to switch between search methods.

- 1 Hold down the FUNC key and press the dial knob to change the setting.
- 2 Turn the dial knob to select setting number 08.

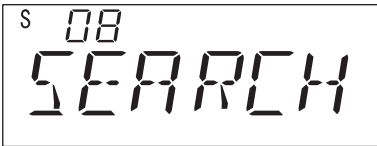

- 3 Hold down the FUNC key and turn the dial knob to select the search method.
  - VFO Search  
Select "VFO" to search between 0.1 MHz and 1299.995 MHz in VFO.

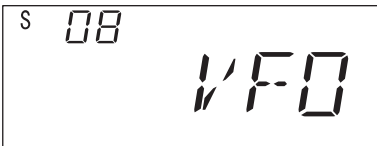

- Limit Search  
Select "LIMIT" to search in a limited range.

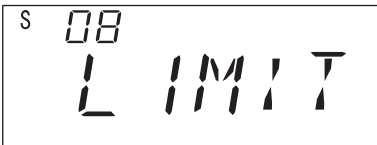

- Limit Link Search  
Select "LTLNK" to search in a linked limited range.



- 4 To return to the original display, press the dial knob or V/M key.

# CHANGING SETTINGS

## Setting the Memory Scan

This setting is used for switching memory scan methods.

**1** Hold down the FUNC key and press the dial knob to change the setting.

**2** Turn the dial knob to select setting number 09.

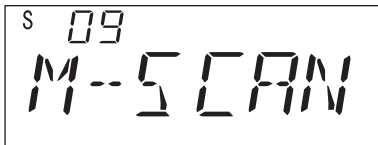

**3** Hold down the FUNC key and turn the dial knob to select the memory scan method.

- All Scan  
Select "ALL" to scan all memory.

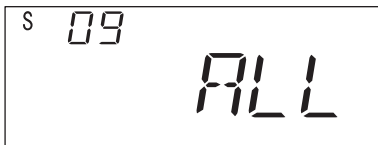

- Bank Scan  
Select "BANK" to scan all memory within a bank memory.

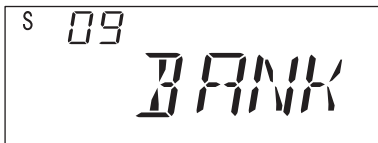

- Bank Link Scan  
Select "BKLNK" to scan all memory within a linked memory bank

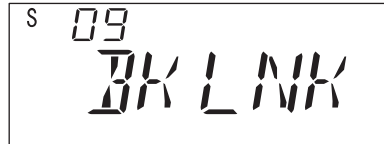

**4** To return to the original display, press the dial knob or V/M key.



# CHANGING SETTINGS

## Setting the Limit Link Search

This setting is used for linking a limit search.

- 1 Hold down the FUNC key and press the dial knob to change the setting.
- 2 Turn the dial knob to select setting number 10.

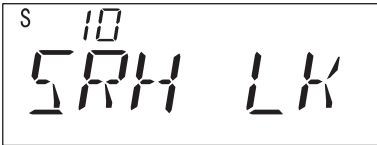

- 3 Hold down the FUNC key and turn the dial knob to select the limit link number to be linked.
  - The setting number will be replaced with a search band memory number.

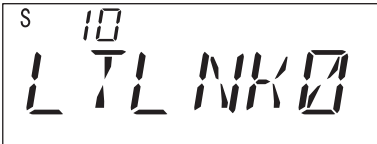

- 4 Release the FUNC key.
  - The search link mark is displayed.

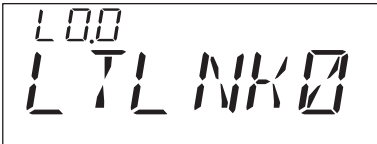

- 5 Press the dial knob to return step 2.
- 6 To return to the original display, press the dial knob or V/M key.

### Tips:

When the link limit search is cancelled, repeat steps 1 through 3 and select the link limit search number to be cancelled. Then press the dial knob.

# CHANGING SETTINGS

## Setting the Memory for a Memory Bank Link Scan

This setting is used for setting memory banks that are linked for a scan.

- 1 Hold down the FUNC key and press the dial knob to change the setting.
- 2 Turn the dial knob to select setting number 11.

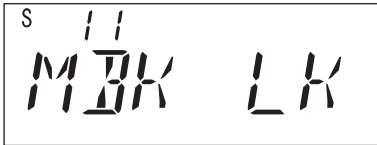

- 3 Hold down the FUNC key and turn the dial knob to select the memory bank number to be linked.

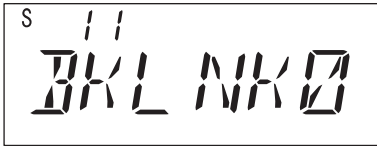

- 4 Press the dial knob.
  - The bank link mark will be displayed.



- 5 Press the dial knob to return to step 2.
- 6 To return to the original display, press the dial knob or V/M key.

### Tips:

When the memory bank link is cancelled, repeat steps 1 through 4 and select the memory bank number to be cancelled. Erase “.” (bank link mark) by pressing the dial knob.

# CHANGING SETTINGS

## Confirming Limit Search Frequencies

This setting is used for confirming the frequencies in a set limit search.

The upper frequency and lower frequency are displayed in alternation every second.

- 1 Hold down the FUNC key and press the dial knob to change the setting.
- 2 Turn the dial knob to select setting number 12.

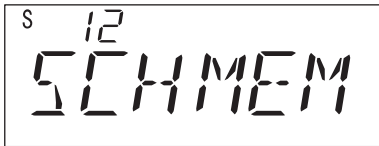

- 3 Hold down the FUNC key and turn the dial knob to confirm.



- 4 Press the dial knob to return step 2.
- 5 To return to the original display, press the dial knob or V/M key.

### Tips:

- In step 3, up to 24 pairs of limit search frequencies can be confirmed.
- This procedure is only for confirmation. The setting cannot be changed.

## Erasing All Memory from a Memory Bank

This setting is used for erasing all memory from a memory bank.

- 1 Hold down the FUNC key and press the dial knob to change the setting.
- 2 Turn the dial knob to select setting number 13.

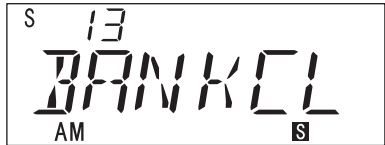

- 3 Hold down the FUNC key and turn the dial knob.

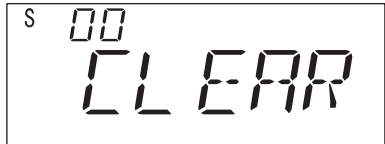

- 4 Turn the dial to select the bank number to be erased.
- 5 Hold down the FUNC key and press the V/M key.

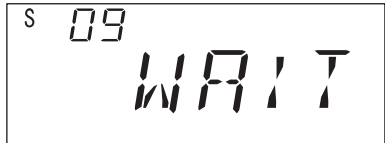

- 6 Press the dial knob.
  - The memory stored in the memory bank will be erased, and then next memory bank number is displayed.
  - To cancel this procedure, press the V/M key to exit.

# CHANGING SETTINGS

- Repeat from the step 3 to erase other memory.
- To return to the original display, press the dial knob or V/M key.

**Tips:**

In step 3, memory banks containing no memory will not be displayed.

## Erasing VFO Skip Memory

This setting is used for erasing VFO skip memory. The VFO skip memory enables stored frequencies to be skipped when searching.

- Hold down the FUNC key and press the dial knob to change the setting.
- Turn the dial knob to select setting number 14.



- Hold down the FUNC key and turn the dial knob to set "CLEAR".

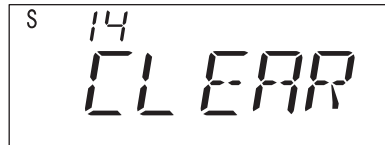

- Press the dial knob.
  - The VFO skip memory will be erased.
  - To cancel this procedure, press the V/M key to exit.
- Press the dial knob to return step 2.
- To return to the original display, press the dial knob or V/M key.

**Tips:**

In step 3, "CLEAR" will not be displayed if there is no VFO skip memory stored.

# CHANGING SETTINGS

## Erasing the Memory Channel's Skip Mark

This setting is used for erasing the skip mark of the memory channel. The skip mark is stored to skip the marked channels in the scan function.

- 1 Hold down the FUNC key and press the dial knob to change the setting.
- 2 Turn the dial knob to select setting number 15.

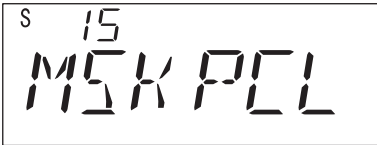

- 3 Hold down the FUNC key and turn the dial knob to set CLEAR.

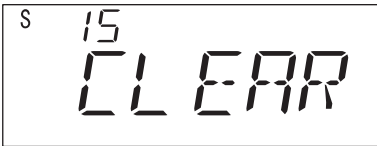

- 4 Press the dial knob (the LCD shows "WAIT").
  - After approx. 25 seconds the LCD will show "CLEAR". At this time the skip memory will be erased.
- 5 Press the dial knob to return step 2.
- 6 To return to the original display, press the dial knob or V/M key.

### Tips:

In Step 3, CLEAR will not be displayed if there is no skip memory stored.

## Cancelling Muting during a Scan

By default, the voice is muted during a scan or search. This setting is used for cancelling the muting.

- 1 Hold down the FUNC key and press the dial knob to change the setting.
- 2 Turn the dial knob to select setting number 16.



- 3 Hold down the FUNC key and turn the dial knob to set OFF.
  - If you select OFF, the muting will be cancelled

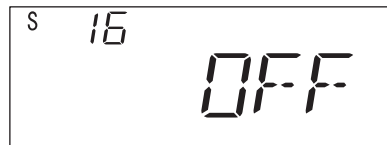
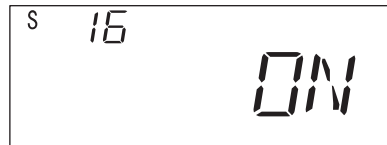

- 4 To return to the original display, press the dial knob or V/M key.

# CHANGING SETTINGS

## Antenna Selection

By default AR-mini is using the built-in bar antenna for frequencies between 100 kHz and 5 MHz. If you wish to bypass this setting to use the supplied antenna or another external antenna between 100 kHz and 5 MHz, proceed as follows:

- 1 Hold down the FUNC key and press the dial knob.
- 2 Turn the dial knob to select setting number 17.

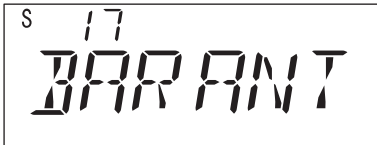

- 3 Hold down the FUNC key and turn the dial knob to set "EXT".

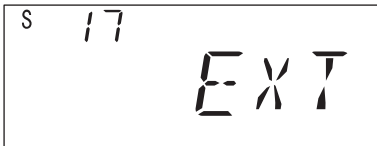

- To set the built-in antenna, turn the dial knob to select "BAR".

- 4 To return to the original display, press the dial knob or V/M key.

### Tips:

Please note that if the antenna type is not matched, or the antenna signal is too strong, AR-mini will overload and reception sensitivity will be reduced. In most cases any large external antenna will NOT improve reception, but a simple telescopic whip antenna will.

Special note to TESTERS: This antenna selection issue is important for someone who would perform sensitivity, IP3, etc... measurements. If the setting is not changed to EXT, test results would appear extremely bad on shortwave.

## Using the Earphone as an Antenna

This setting uses the earphone as an antenna. This setting is available for all bands on this receiver.

- 1 Hold down the FUNC key and press the dial knob to change the setting.
- 2 Turn the dial knob to select setting number 18.



- 3 Hold down the FUNC key and turn the dial knob to set "EARANT" or "EXT".

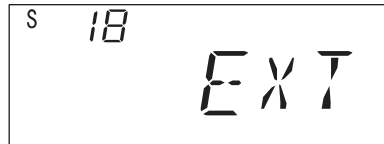

- 4 To return to the original display, press the dial knob or V/M key.

### Tips:

Under these settings, an earphone should always be connected to the receiver. If no earphone is connected, reception sensitivity will be reduced.

# CHANGING SETTINGS

## Automatically Increasing the Volume in FM

This setting is used for automatically increasing the volume to 6 dB in FM when a 12.5 kHz step is set.

- 1 Hold down the FUNC key and press the dial knob to change the setting.
- 2 Turn the dial knob to select setting number 19.



- 3 Hold down the FUNC key and turn the dial knob to set ON.

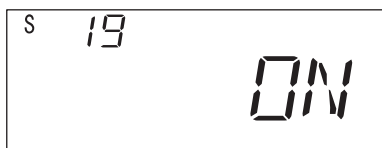

- 4 To return to the original display, press the dial knob or V/M key.

### Tips:

This setting is available only in FM.

## Setting Tone Frequency

This is used to set one of the 50 selectable tone frequencies.

- 1 Hold down the FUNC key and press the dial knob to change the setting.
- 2 Turn the dial knob to select setting number 20.



- 3 Hold down the FUNC key and turn the dial knob to select the tone frequency.

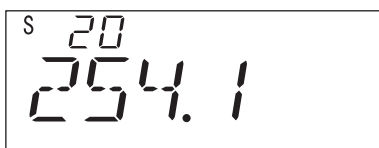
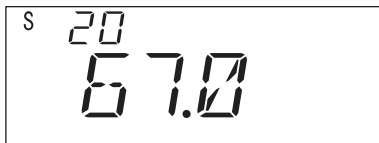

- 4 To return to the original display, press the dial knob or V/M key.

### Tips:

Tone frequencies are listed in the table on page 73.

# CHANGING SETTINGS

## Selecting Reversed Tone Frequency

This setting is used to select the reversed tone frequency.

- 1 Hold down the FUNC key and press the dial knob to change the setting.
- 2 Turn the dial knob to select setting number 21.

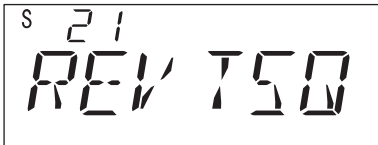

- 3 Hold down the FUNC key and turn the dial knob to select the tone frequency to be reversed.



- 4 To return to the original display, press the dial knob or V/M key.

## Selecting Voice Inverter Carriers

(Not available for US domestic version)

This setting is used for selecting the carrier frequencies of voice inverted frequencies. Carrier frequencies can be selected so as to be clearly audible. There are 16 selectable carrier frequencies between 3200 Hz and 3500 Hz in 20 Hz steps.

- 1 Hold down the FUNC key and press the dial knob to change the setting.
- 2 Turn the dial knob to select setting number 23.

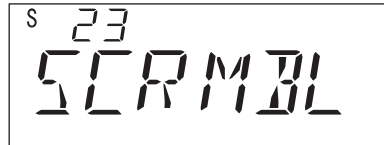

- 3 Hold down the FUNC key and turn the dial knob to select the carrier frequency.

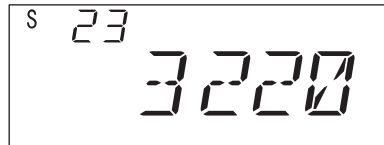

- 4 To return to the original display, press the dial knob or V/M key.



# CHANGING SETTINGS

## Automatically Switching the Display Information

This setting is used for switching the display from the volume or squelch display to the frequency display automatically when the setting time has passed.

- 1 Hold down the FUNC key and press the dial knob to change the setting.
- 2 Turn the dial knob to select setting number 24.

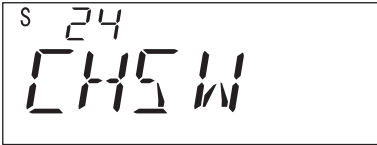

- 3 Hold down the FUNC key and turn the dial knob to select the setting time to be changed.
  - The setting time can be set as follows; 0.5 seconds, 1 second, 2 seconds, 3 seconds, 4 seconds, 5 seconds and OFF



- 4 To return to the original display, press the dial knob or V/M key.

### Tips:

In step 3, the display will not be changed automatically if OFF is selected.

## Setting DCS Codes

This is used to set one of the 104 selectable DCS codes.

- 1 Hold down the FUNC key and press the dial knob to change the setting.
- 2 Turn the dial knob to select setting number 25.

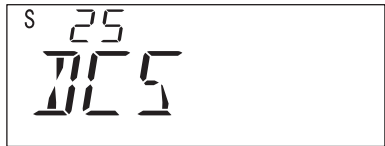

- 3 Hold down the FUNC key and turn the dial knob to select the DCS code.



- 4 To return to the original display, press the dial knob or V/M key.

### Tips:

The DCS codes are listed in the table on page 72.

# CHANGING SETTINGS

## Setting the DCS Code Phases

This setting is used for the phase of DCS codes that have been set.

- 1 Hold down the FUNC key and press the dial knob to change the setting.
- 2 Turn the dial knob to select setting number 26.

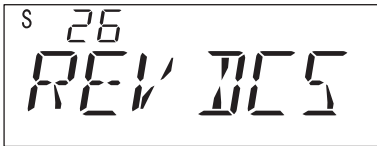

- 3 Hold down the FUNC key and turn the dial knob to set the phase.
  - The DCS code phase will not be reversed when "NORMAL" is selected.
  - When REV is selected, a phase of the DCS code will be reversed.

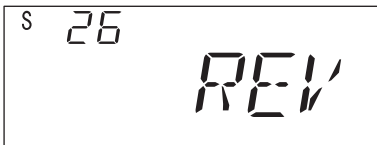
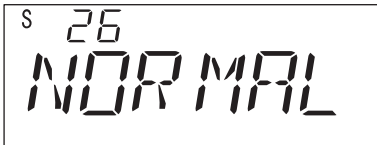

- 4 To return to the original display, press the dial knob or V/M key.

### Tips:

This function has no icon. Therefore, the setting status should be confirmed in this procedure.

## Turning the Beep Off

This setting is used for turning the beep off.

- 1 Hold down the FUNC key and press the dial knob to change the setting.
- 2 Turn the dial knob to select setting number 27.

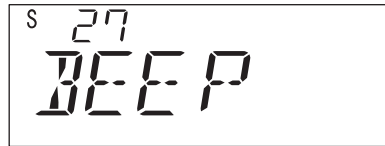

- 3 Hold down the FUNC key and turn the dial knob to set OFF.



- 4 To return to the original display, press the dial knob or V/M key.

# CHANGING SETTINGS

## Changing the Battery Saving Time

This setting is used for changing the battery saving time.

- 1 Hold down the FUNC key and press the dial knob to change the setting.
- 2 Turn the dial knob to select setting number 28.

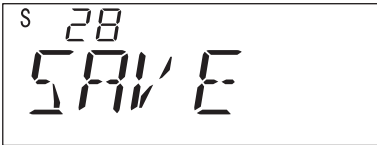

- 3 Hold down the FUNC key and turn the dial knob to set the desired time.
  - The battery save time can be selected as followings:  
1 second, 3 seconds, 5 seconds, 7 seconds, 9 seconds and OFF.

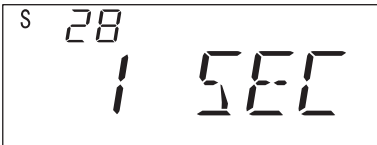

- 4 To return to the original display, press the dial knob or V/M key.

### Tips:

In step 3, the battery save function will be cancelled when OFF is selected

## Displaying Battery Voltage

This setting is used for displaying the battery voltage.

- 1 Hold down the FUNC key and press the dial knob to change the setting.
- 2 Turn the dial knob to select setting number 29.

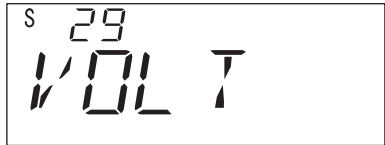

- 3 Hold down the FUNC key and turn the dial knob to display the voltage.



- 4 Press the dial knob to return to step 2.
- 5 To return to the original display, press the dial knob or V/M key.

# CHANGING SETTINGS

## Charging the Ni-MH Battery

This setting is only available for the supplied Ni-MH batteries. Never use this setting for other batteries.

- 1 Hold down the FUNC key and press the dial knob to change the setting.
- 2 Turn the dial knob to select setting number 30.



- 3 Hold down the FUNC key and turn the dial knob to set "CHARG".

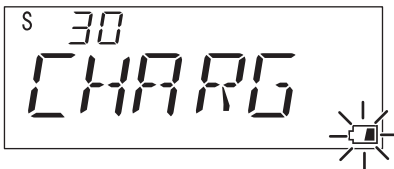

- 4 To return to the original display, press the dial knob or V/M key.

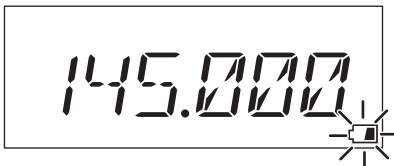

- 5 To charge the battery, turn the power off by pressing the PWR key for 2 seconds or longer.



- "CHARG" will be displayed and "  " will blink.
- 6 Connect the AC adapter AA-mini or DC adapter DC-mini.
    - Refer to page 16, 21 to connect the AA-mini or DC-mini

### Note:

- Disconnect the AA-mini or DC-mini after approximately 20 hours have passed.
- Charging ends automatically after 24 hours in order to maintain safety.
- In step 5, "CHARG" will be displayed even if no battery is installed. Therefore, you should confirm that the specific batteries are installed.
- The AR-mini may be turned on by inserting the AA-mini or DC-mini when no battery is installed or when the batteries are depleted. This is not a malfunction.

# CHANGING SETTINGS

## Revising Step Frequency

This receiver can automatically revise step frequencies to match the channel plan. This setting can also be used for cancelling any revisions.

- 1 Hold down the FUNC key and press the dial knob to change the setting.
- 2 Turn the dial knob to select setting number 32.

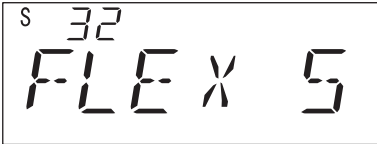

- 3 Hold down the FUNC key and turn the dial knob to set OFF.

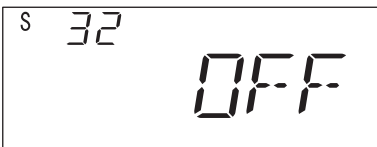
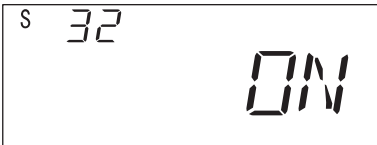

- 4 To return to the original display, press the dial knob or V/M key.

### Tips:

The step frequency is not revised automatically while this setting is set OFF, except for the 6.25 Hz and 12.5 Hz step.

## Shifting the Microprocessor's Clock Frequency

This setting is used to prevent the undesirable influence of the microprocessor's clock frequency.

- 1 Hold down the FUNC key and press the dial knob to change the setting.
- 2 Turn the dial knob to select setting number 33.

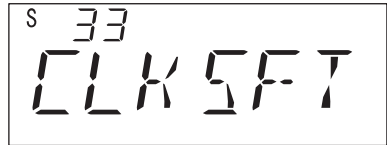

- 3 Hold down the FUNC key and turn the dial knob to set ON.

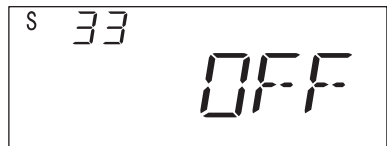

- 4 To return to the original display, press the dial knob or V/M key.

### Tips:

This setting is cancelled by changing the channel or turning the power off.

# APPENDIX

## Broadcast Facility Frequencies

### *For U.S.A. version*

Memory No.	Initial frequency	Frequency Range	Remark
r-0	1.6200 AM	0.520 – 1.620	AM radio 10 kHz step
r-1	80.00 WFM	76.0 – 107.9 MHz	FM radio 50 kHz step
r-2	TV 2ch	TV 2ch – 69ch	USA TV
r-3	6.030 AM	3.00 – 11.995	VOA
r-4	WX01	WX01 – WX10	Marine weather channel

### *For European version*

Memory No.	Initial frequency	Frequency Range	Remark
r-0	1.6200 AM	0.531 – 1.620	AM radio 9 kHz step
r-1	80.00 WFM	76.0 – 107.9 MHz	FM radio 50 kHz step
r-2	TV 1ch	TV 1ch – 69ch	CCIR TV
r-3	9.410 AM	3.00 – 11.995	BBC
r-4	PMR 1 FM	PMR 1ch – 8ch	PMR446

Refer to “Using Broadcast Mode” on page 45.

## Bug Frequencies

26.0950	136.6000	142.9000	298.9800	395.7500	398.3100	399.4300	407.9050
27.0000	139.4000	143.2050	299.3200	396.4300	398.4500	399.4500	410.1100
27.1450	139.4500	143.7800	339.0300	396.4400	398.4550	399.4550	410.9700
32.0000	139.6000	143.8500	339.2500	396.6050	398.4600	399.5750	411.8350
34.4500	139.7000	143.8800	339.4500	396.8200	398.6000	399.5900	418.5650
36.6650	139.9000	143.9100	350.1250	397.2400	398.6050	399.6050	428.6350
75.6000	139.9400	143.9400	361.8200	397.2500	398.6400	399.6150	441.1150
76.0000	139.9600	143.9700	361.8250	397.5650	398.6450	399.6400	442.8000
105.8500	139.9750	149.0000	365.0500	398.0100	398.6500	399.6500	442.9000
110.1500	139.9800	149.4500	367.4000	398.0300	398.9500	399.7500	444.1150
124.0900	140.0000	149.5050	368.8000	398.0500	399.0000	399.9100	444.8850
134.0000	140.0500	149.8950	380.4250	398.0650	399.0250	399.900	445.6650
134.1600	140.4500	153.3500	380.6875	398.1100	399.0300	400.0000	600.5000
134.9000	140.5000	154.0000	389.6050	398.2150	399.2375	406.5200	
135.3650	141.0000	154.5850	390.6400	398.3050	399.2500	407.2100	

Refer to “Searching Bug Frequencies” on page 49.

# APPENDIX

## Preset Memory Frequencies

### *For U.S.A. version*

Preset No.	Initial frequency	Remark
P00	1.6200 AM	MW Broadcast
P01	6.030 AM	SW Broadcast (VOA)
P02	51.000 FM	Amateur radio
P03	82.500 WFM	FM Broadcast
P04	128.800 AM	Air Band
P05	156.800 FM	Land Mobile radio
P06	145.000 FM	Amateur radio
P07	162.550 FM	Marine radio (Weather)
P08	438.000 FM	Amateur radio
P09	462.5625 FM	FRS
P10	1260.000 FM	Amateur radio
P11	TV 2ch WFM	Television Broadcast
P12	MEM980 FM	Frequencies 980 to 999 stored by user. (*)

(\*) Refer to page 39 "Storing a Frequency in Memory".

### *For European version*

Preset No.	Initial frequency	Remark
P00	1.6200 AM	MW Broadcast
P01	9.410 AM	SW Broadcast (BBC)
P02	51.000 FM	Amateur radio
P03	82.500 WFM	FM Broadcast
P04	128.800 AM	Air Band
P05	156.800 FM	Land Mobile radio
P06	145.000 FM	Amateur radio
P07	156.300 FM	Marine radio
P08	433.000 FM	Amateur radio
P09	446.00625 FM	LPD (PMR446)
P10	1260.000 FM	Amateur radio
P11	TV 33ch WFM	Television Broadcast
P12	MEM980 FM	

Refer to "Using PRESET" on page 45.

# APPENDIX

## Shortwave Broadcast Station List

Display	Memory Channel	Frequency (MHz)	Display	Memory Channel	Frequency (MHz)	Display	Memory Channel	Frequency (MHz)	Display	Memory Channel	Frequency (MHz)
VOA	800	6.030	ITALY	842	6.060	DENMAR	910	9.590	INDIA	942	6.045
	801	6.160		843	7.175		911	9.985		943	9.595
	802	9.760		844	9.515		912	13.800		944	11.620
	803	11.930		845	17.710		913	15.735		945	15.020
CANADA	805	5.995	BELGIU	848	5.985	NORWAY	916	7.485	CHINA	948	7.190
	806	7.235		849	9.925		917	9.590		949	5.250
	807	9.735		850	11.780		918	9.985		950	9.855
	808	11.705		851	13.740		919	13.800		951	11.685
PORTUG	816	9.780	NEDERL	853	5.955	SWEDEN	921	6.065	KOREA	952	5.975
	817	11.960		854	6.020		922	9.490		953	7.275
	818	15.555		855	9.895		923	13.625		954	9.570
	819	21.655		856	11.655		924	17.505		955	13.670
SPAIN	821	7.270	LUXEMB	858	6.090	FINLAN	926	6.120	JAPAN	956	6.155
	822	9.520		—	—		927	9.630		957	7.200
	823	11.920		—	—		928	11.755		958	9.750
	824	15.585		—	—		929	9.795		959	11.850
BBC	832	6.195	WELLE	900	3.955	RUSSIA	932	5.940	AUSTRA	960	5.995
	833	9.410		901	6.075		933	5.920		961	9.580
	834	12.095		902	9.545		934	7.205		962	9.660
	835	15.310		903	9.735		935	12.030		963	12.080
FRANCE	837	6.045	SWISS	905	3.985	ISRAEL	937	9.435	—	—	—
	838	9.790		906	6.165		938	11.585		—	—
	839	11.670		907	9.885		939	15.615		—	—
	840	15.525		908	15.220		940	17.545		—	—

Refer to “MEMORY” on page 38 and “Recalling Memory” on page 39.



# APPENDIX

## Tone Frequency List (CTCSS)

Tone frequency (Hz)									
67.0	79.7	94.8	110.9	131.8	156.7	171.3	186.2	203.5	229.1
69.3	82.5	97.4	114.8	136.5	159.8	173.8	189.9	206.5	233.6
71.9	85.4	100.0	118.8	141.3	162.2	177.3	192.8	210.7	241.8
74.4	88.5	103.5	123.0	146.2	165.5	179.9	196.6	218.1	250.3
77.0	91.5	107.2	127.3	151.4	167.9	183.5	199.5	225.7	254.1

Refer to “Using Tone Squelch” on page 46.

## DCS Code List

023	072	152	244	311	412	466	631
025	073	155	245	315	413	503	632
026	074	156	246	325	423	506	654
031	114	162	251	331	431	516	662
032	115	165	252	332	432	523	664
036	116	172	255	343	445	526	703
043	122	174	261	346	446	532	712
047	125	205	263	351	452	546	723
051	131	212	265	356	454	565	731
053	132	223	266	364	455	606	732
054	134	225	271	365	462	612	734
065	143	226	274	371	464	624	743
071	145	243	306	411	465	627	754

Refer to “Using DCS” on page 47.

# APPENDIX

## Search Band Memory List

No.	Lower frequency (MHz)	Upper frequency (MHz)	No.	Lower frequency (MHz)	Upper frequency (MHz)
L00	118.000	141.9750	L12	466.0500	467.3750
L01	154.450	154.6100	L13	466.3500	466.5500
L02	156.025	162.0250	L14	465.0375	465.1500
L03	225.000	382.7000	L15	468.5500	468.8500
L04	348.5625	348.7750	L16	797.12500	809.7500
L05	358.5250	358.9375	L17	851.000	859.9875
L06	322.0250	322.5000	L18	896.000	899.9875
L07	380.2125	381.3125	L19	903.0125	904.9870
L08	422.0500	422.3000	L20	144.000	146.000
L09	450.0125	451.5000	L21	430.000	440.000
L10	453.3000	453.3500	L22	1260.000	1299.9875
L11	458.2500	459.5000	L--	*	*

\* The frequencies are depending on "Limit Search" on page 35.

Refer to "Changing the Search Band Memory" on page 36.

## 2VFO Watch Memory List

2VFO memory No.	Frequency (MHz)	MODE	2VFO memory No.	Frequency (MHz)	MODE
A00	10.0000	AM	A05	1000.0000	FM
b00	100.0000	WFM	b05	1100.0000	FM
A01	200.0000	WFM	A06	1200.0000	FM
b01	300.0000	AM	b06	1299.9950	FM
A02	400.0000	FM	A07	145.0000	FM
b02	500.0000	WFM	b07	433.0000	FM
A03	600.0000	WFM	A08	433.0000	FM
b03	700.0000	WFM	b08	1295.0000	FM
A04*	800.0000	FM	A--	2VFO Watch**	
b04*	902.0000	FM	b--		

\* Cellular frequencies blocked for US consumer version.

\*\* These memories are set depending on 2VFO watch, detailed on page 32.

Refer to "2VFO Watch" on page 32 and "2VFO Watch with 2VFO Watch Reception Memory" on page 33.

# APPENDIX

## Setting Number List

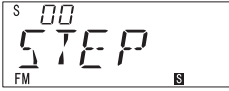
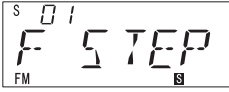
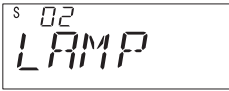
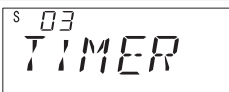
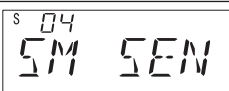
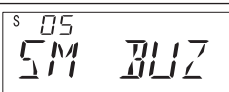
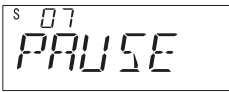
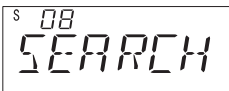
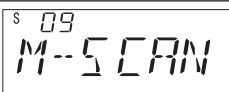
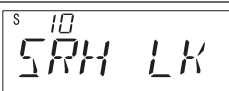
Setting No.	Initial Display	Function	Page
00		Changing steps	P. 51
01		Changing fast steps	P. 51
02		Setting the lamp function	P. 52
03		Setting the timer	P. 52
04		Setting the S-meter sensitivity	P. 53
05		Setting the S-meter buzzer	P. 54
06		(This setting is unavailable for this product.)	—
07		Setting the resumption time	P. 54
08		Setting the search	P. 55
09		Setting the memory scan	P. 56
10		Setting the limit link search	P. 57

# APPENDIX

Setting No.	Initial Display	Function	Page
11		Setting the memory for a memory bank link scan	P. 58
12		Confirming limit search frequencies	P. 59
13		Erasing all memory from a memory bank	P. 59
14		Erasing VFO skip memory	P. 60
15		Erasing the memory channel's skip mark	P. 61
16		Cancelling muting during a scan	P. 61
17		Antenna selection	P. 62
18		Using the earphone as an antenna	P. 62
19		Increasing the volume automatically in FM	P. 63
20		Setting the tone frequency	P. 63
21		Selecting reversed tone frequency	P. 64
22		(This setting is unavailable for this product.)	—

# APPENDIX

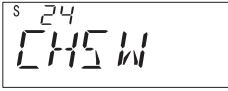
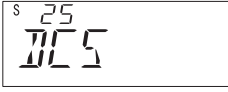
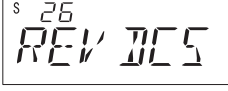
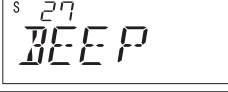
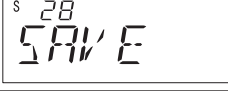
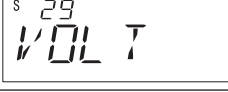
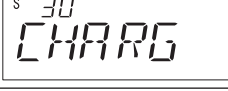
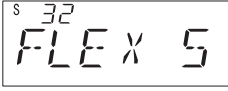
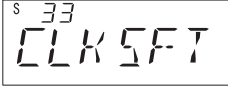
Setting No.	Initial Display	Function	Page
23		Selecting Voice Inverter Carriers (Not available for US domestic version)	P. 64
24		Switching the display information automatically	P. 65
25		Setting DCS codes	P. 65
26		Setting DCS code phases	P. 66
27		Turing the beep off	P. 66
28		Changing the battery saving time	P. 67
29		Displaying the battery voltage	P. 67
30		Charging the Ni-MH Battery	P. 68
31		(This setting is unavailable for this product.)	-
32		Revising the step frequency	P. 69
33		Shifting the microprocessor's clock frequency	P. 69

# APPENDIX

## Troubleshooting

Symptom	Cause	Solution
No power	The battery is consumed.	Replace new battery. Charge the battery.
	The battery polarity is different.	Insert the battery correctly.
	Time to press the PWR key is short.	Press the PWR key for 2 seconds or longer.
No reception	The antenna is not correctly attached.	Attach the antenna correctly.
	A frequency is not tuned.	Tune the frequency correctly.
	Selected antenna is different.	Select the correct antenna type with setting number 17 or 18.
	Attenuator function is set.	Cancel attenuator function.
No audio	Volume setting is too low.	Increase the volume.
	A frequency is not tuned.	Tune the frequency correctly.
	The reception mode is different.	Set the reception mode.
	Squelch value is set too large.	Set the squelch to "Threshold".
	Tone squelch frequency is different.	Set the tone squelch correctly.
Audio is distorted	DCS code is different.	Set the code correctly.
	A frequency is not tuned.	Tune the frequency correctly.
Noise is emitted	The reception mode is different.	Set the reception mode.
	Squelch value is set too small.	Set the squelch to "Threshold".
Search is not started	Squelch value is set too small.	Set the squelch to "Threshold".
Specific frequency is skipped.	Search skip is set.	Cancel the search skip.
Scan is not started	Squelch value is set too small.	Set the squelch to "Threshold".
Keys do not respond	Key lock function is set.	Cancel key lock function.

# APPENDIX

## Specifications

Frequency range .....	100 kHz – 1299.995 MHz (*)		
Circuit type.....	AM, FM: Triple conversion super-heterodyne WFM: double conversion super-heterodyne		
Receiving modes .....	AM, WFM, NFM		
I.F bandwidth .....	AM/NFM: 15 kHz, WFM: 220 kHz		
Memory channels .....	1000 (10 banks x 100 channels)		
Scan speed .....	8 steps/sec		
Select scan channels.....	100		
Priority channels .....	1		
Pass frequencies .....	100		
Sensitivity (typical)	AM (10 dB S/N) .....	0.2–5 MHz	1.3 $\mu$ V
		5–160 MHz	0.6 $\mu$ V
		160–370 MHz	0.6 $\mu$ V
		370–520 MHz	0.6 $\mu$ V
		520–1300 MHz	0.7 $\mu$ V
	FM (12 dB SINAD) .....	5–160 MHz	0.2 $\mu$ V
		160–370 MHz	0.2 $\mu$ V
		370–520 MHz	0.28 $\mu$ V
		520–1300 MHz	0.35 $\mu$ V
	WFM (12 dB SINAD).....	5–160 MHz	0.9 $\mu$ V
		160–370 MHz	0.8 $\mu$ V
		370–520 MHz	1 $\mu$ V
		520–1300 MHz	1 $\mu$ V
Intermediate frequencies .....	243.95 MHz, 21.7 MHz, 450 kHz		
Tuning steps.....	.5, 6.25, 8.33*, 9*, 10, 12.5, 15, 20, 25, 30, 50, 100 kHz (* Selectable depending on bands)		
Selectivity.....	AM/FM: More than 15 kHz / -6 dB WFM: More than 110 kHz / -6 dB		
Conducted spurious emission.....	less than -57 dBm		
Frequency stability.....	$\pm$ 2.5 ppm (by TCXO)		
AF output power .....	100 mW, at 10% distortion with an 8 $\Omega$ load		
External speaker connector.....	3.5 mm jack (MONO)		
Antenna connector .....	SMA (50 $\Omega$ )		
Battery requirement.....	2 x AA (LR6) Ni-MH or alkaline cells		
Battery life.....	Approx. 22 h in normal listening mode		
External power supply .....	6V DC, 500 mA		
Current drain .....	Approx. 110 mA (Receive, AF output 50 mW) 20 mA (Standby, saver 1:4 on) 65 mA (Standby, saver off)		
Operating temperature .....	-10°C – +50°C		
Dimensions (projections excluded) .....	60(W) x 95(H) x 24(D) mm 2.4" x 3.7" x 0.9"		
Weight .....	210 g (with antenna and batteries) 7.4 oz		

Specifications are subject to change without notice or obligation.

(\*) Cellular frequencies locked in the U.S.A version. Unblocked version available to qualified purchasers.



**AOR, LTD.**

2-6-4 Misuji, Taito-ku, Tokyo,  
111-0055, Japan  
[www.aorja.com](http://www.aorja.com)  
[mail@aorja.com](mailto:mail@aorja.com)

**AOR USA, INC.**

20655 S. Western Ave, Suite 112  
Torrance, CA 90501, U.S.A  
Phone: 310-787-8615  
Fax: 310-787-8619  
[www.aorusa.com](http://www.aorusa.com)  
[info@aorusa.com](mailto:info@aorusa.com)

© 2008 AOR, LTD. All rights reserved.

Printed in Japan.

00M63AC851012